

## REFERENCE 9

**D. CALLIHAN, "EXPERIMENTS FOR CRITICALITY CONTROL," IN CRITICALITY CONTROL IN CHEMICAL AND METALLURGICAL PLANT, KARLSRUHE SYMPOSIUM, 1961 (ORGANISATION FOR ECONOMIC COOPERATION AND DEVELOPMENT, EUROPEAN NUCLEAR ENERGY AGENCY, PARIS 1961), PP. 589-614.**

**CRITICALITY CONTROL  
IN CHEMICAL AND METALLURGICAL PLANT**

**CONTROLE DE LA CRITICALITE  
DANS LES INSTALLATIONS CHIMIQUES ET MÉTALLURGIQUES**

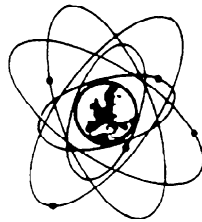

**KARLSRUHE SYMPOSIUM**

**1981**

**ORGANISATION FOR ECONOMIC CO-OPERATION AND DEVELOPMENT  
EUROPEAN NUCLEAR ENERGY AGENCY**

**ORGANISATION DE COOPÉRATION ET DE DÉVELOPPEMENT ÉCONOMIQUES  
AGENCE EUROPÉENNE POUR L'ÉNERGIE NUCLÉAIRE**

L'Organisation de Coopération et de Développement Économiques a été instituée par une Convention signée le 14 décembre 1960, à Paris, par les Membres de l'Organisation Européenne de Coopération Économique, ainsi que par le Canada et les États-Unis. Aux termes de cette Convention, l'O.C.D.E. a pour objectif de promouvoir des politiques visant :

- à réaliser la plus forte expansion possible de l'économie et de l'emploi et une progression du niveau de vie dans les pays Membres, tout en maintenant la stabilité financière, et à contribuer ainsi au développement de l'économie mondiale ;
- à contribuer à une saine expansion économique dans les pays Membres, ainsi que non membres, en voie de développement économique ;
- à contribuer à l'expansion du commerce mondial sur une base multilatérale et non discriminatoire, conformément aux obligations internationales.

La personnalité juridique que possédait l'Organisation Européenne de Coopération Économique se continue dans l'O.C.D.E., dont la création a pris effet le 30 septembre 1961.

Les Membres de l'O.C.D.E. sont : la République fédérale d'Allemagne, l'Autriche, la Belgique, le Canada, le Danemark, l'Espagne, les États-Unis, la France, la Grèce, l'Irlande, l'Islande, l'Italie, le Luxembourg, la Norvège, les Pays-Bas, le Portugal, le Royaume-Uni, la Suède, la Suisse, la Turquie.

L'Agence Européenne pour l'Énergie Nucléaire (ENEA) a été créée en décembre 1957 dans le cadre de l'O.E.C.E. afin de développer la collaboration atomique entre l'ensemble des pays de l'Europe occidentale. Un Comité de Direction de l'Énergie Nucléaire comprenant des représentants de tous les pays Membres et Associés est l'organe directeur de l'ENEA.

L'Agence a pour fonctions de (a) créer des entreprises communes ; trois entreprises ont été constituées : la Société Eurochemic pour le retraitement des combustibles irradiés (à Mol, Belgique), le Projet de réacteur à eau lourde bouillante de Halden (Norvège), le Projet Dragon de réacteur à haute température refroidi par gaz (à Winfrith, Royaume-Uni) ; (b) harmoniser les programmes de recherches en facilitant la coopération entre les pays Membres dans les domaines scientifiques et techniques, les échanges de personnel et d'informations ; (c) élaborer des règles uniformes en matière nucléaire pour l'ensemble de l'Europe, notamment dans les domaines de la santé et de la sécurité, du transport des matières radioactives, de la responsabilité civile et des assurances ; (d) étudier les aspects économiques de l'énergie nucléaire en examinant périodiquement les programmes nationaux, la place de l'énergie nucléaire dans la balance énergétique de l'Europe et le marché des combustibles, matériaux et équipements nucléaires.

L'ENEA travaille en liaison avec les autres organisations internationales intéressées, particulièrement avec l'Euratom et l'Agence Internationale de l'Énergie Atomique.

The Organisation for Economic Co-operation and Development was set up under a Convention signed in Paris on 14th December 1960 by the Member countries of the Organisation for European Economic Co-operation and by Canada and the United States. This Convention provides that the O.E.C.D. shall promote policies designed:

- to achieve the highest sustainable economic growth and employment and a rising standard of living in Member countries, while maintaining financial stability, and thus to contribute to the development of the world economy;
- to contribute to sound economic expansion in Member as well as non-Member countries in the process of economic development;
- to contribute to the expansion of world trade on a multilateral, non-discriminatory basis in accordance with international obligations.

The legal personality possessed by the Organisation for European Economic Co-operation continues in the O.E.C.D., which came into being on 30th September 1961.

The Members of O.E.C.D. are: Austria, Belgium, Canada, Denmark, France, the Federal Republic of Germany, Greece, Iceland, Ireland, Italy, Luxembourg, the Netherlands, Norway, Portugal, Spain, Sweden, Switzerland, Turkey, the United Kingdom and the United States.

The European Nuclear Energy Agency (ENEA) was set up in December 1957 as part of the O.E.E.C. to develop nuclear collaboration between the countries of Western Europe. A Steering Committee for Nuclear Energy, composed of representatives from all Member and Associated countries, is the controlling body of ENEA.

The work of the Agency comprises (a) creation of joint undertakings, three of which — the Eurochemic Company for reprocessing irradiated fuels at Mol in Belgium, the Halden boiling heavy water reactor project in Norway, and the Dragon high-temperature gas-cooled reactor project at Winfrith in the United Kingdom — are already in operation; (b) the harmonisation of research programmes, encouraging scientific and technical co-operation between Member countries and the exchange of information and personnel; (c) the establishment of uniform atomic regulations for Europe, especially in the fields of health and safety, liability and insurance in case of accident, and the transport of radioactive materials; (d) the study of the economic aspects of nuclear energy, by a regular examination of national programmes, of the place of nuclear energy in Europe's overall energy balance sheet, and of the markets for nuclear fuels, materials and equipment.

ENEA works in liaison with the other international organisations concerned, especially Euratom and the International Atomic Energy Agency.

# EXPERIMENTS FOR CRITICALITY CONTROL

D. CALLIHAN

Oak Ridge National Laboratory, United States

## INTRODUCTION

The prevention of unwanted and uncontrolled nuclear chain reactions is of the greatest importance to the advancement of nuclear energy because of both the personnel and property damage which may result and the stigma attached to incidents directly associated with this new and often misunderstood energy source. Public reaction to such occurrences is often far out of proportion to their consequences, tragic though they may be to individuals directly concerned, when measured by the scale used to assess industrial accidents in general and the day-to-day accident experience of individuals. It is particularly necessary that nuclear chain reactions be avoided in operations for processing fissionable materials where, in general, there is little protection of personnel from the attendant radiation and where the personnel themselves are not nuclear reactor specialists knowledgeable in the properties of such chain-reacting systems. On the other hand, these processes must be designed and operated with some appreciation of their costs. The specification of these non-reactor operations with fissionable materials must, therefore, be very carefully prepared in order to achieve both safety and reasonable economy. This requirement demands, *a priori*, sound technical information as design bases. Sources of such information are, at one extreme, direct measurement of equipment, piece by piece, to assure its safety and, at the other extreme, a nuclear-reactor-type calculation of tolerable dimensions and batch sizes.

Present practices in nuclear safety rely strongly upon experimental evidence of the conditions necessary for a particular material to be critical in a particular configuration since uncertainties inherent in the results of reactor calculations, due to deficiencies in both the method and the nuclear constants which must be inserted into the analyses, demand the application of inordinate safety factors. That the emphasis may shift from such a strong dependence upon experiment as the field matures is recognized.

Since a majority of the experiments have provided quite basic information, interpolation and short extrapolation of the results allow their application to many specific problems. The experimental results also serve as important guides in the development and evaluation of analytical methods.

This paper discusses the experimental methods which yield information useful in the solution of criticality problems. Reference is made only to activities within the United States. The discussion is very general, merely indicating the type of experiments and the laboratory requirements. There is no theoretical treatment of the experimental methods.



## EXPERIMENTAL METHODS

The experiments to be considered may be roughly grouped into two types. One includes those in which observations of the neutron multiplying properties of the test material are made directly and is illustrated by well-known critical experiments. In the other type, observation is made of the distribution, in space or in time, of neutrons within the test material and is characterized by exponential experiments.

### *Critical Experiments*

The performance of a critical experiment yielding only a value of a critical quantity is very straightforward and the observations are direct. The fissile material is arranged, with due regard for potential hazards, in the amount required to support a chain reaction. The result defines a critical system under the conditions of the experiment. The establishment of this chain reaction is achieved in the following idealized manner. The requirements are the test material, a source of neutrons, and a detector of neutrons. Observations are made of the increasing neutron count rate as the material is assembled, preferably by remote operation, around the source. These observations provide guidance in the experiment and, finally, establish the system as critical. The increased count rate arises, of course, from fission-produced neutrons supplementing those from the source itself.

A property of a neutron multiplying medium,  $k$ , known as the neutron reproduction factor, is defined as the ratio of the neutron population in successive neutron generations. In anticipation of the discussion which follows, it is noted that if  $k$  is equal to unity, an assembly is critical by definition; if  $k$  is either greater or less than unity, the assembly is either supercritical or subcritical. The count rate observed during the construction of a critical assembly is the sum of source neutrons and those arising from fissions produced both by source neutrons and by progeny of neutrons born in earlier fissions. The count rate,  $C_t$ , is, in this simple consideration:

$$C_t = C_o + kC_o + k^2C_o + \dots + k^nC_o$$

where  $C_o$  is the initial count rate in the absence of any neutron multiplying material and the exponents designate the neutron generation in which the fissions responsible for that term first occurred. This expression can be written as:

$$\frac{C_t}{C_o} = \frac{1}{1-k} \quad \text{for } k < 1$$

and is the source neutron multiplication produced by the assembly as constructed at time  $t$ . It is observed that the state is steady as long as  $k$  is a constant less than unity. Increasing the size of the assembly increases  $k$  and increases the neutron multiplication. In the limit of  $k = 1$ , the source multiplication becomes infinite. During the course of the assembly the reciprocal of the source multiplication,  $C_o/C_t$ , is plotted as a function of the controlling variable. Extrapolation of this plot to zero intercept yields the critical value of the variable, and the approach to a critical condition is thereby guided.

It is interesting to observe that  $k$  is independent of the absolute value of the neutron flux and, since  $k = 1$  is the necessary condition for criticality, critical systems can be operated at very low power. For this reason informa-

tion applicable to megawatt power reactors may be obtained from milliwatt critical experiments. It may also be noted that  $k$  of a finite volume is a function of both the material and the geometry since the latter determines the loss of neutrons by leakage. For an infinite volume,  $k = k_{\infty}$ , a property of the material alone.

To ascertain that a system is indeed critical requires removal of the neutron source, or the production of sufficient fission neutrons to mask its presence, to assure that the fission neutron population is constant in time and that the chain reaction is self-sustaining. Deviations in  $k$  from unity produce exponential changes in the neutron level at a rate depending upon the average neutron lifetime. Since about 0.7 % of the neutrons arising from fission are emitted by fission products which decay with finite half lives, the time behaviour of an assembly with  $k$  no greater than 1.007 is governed primarily by these delayed neutrons. The control of reactors is, indeed, possible only through these neutrons. If  $k$  exceeds 1.007 the system becomes prompt critical and the uncontrollable rate of increase in power is governed by the properties of the material. The margin between delayed critical,  $k = 1.000$ , and prompt critical,  $k = 1.007$ , is, perhaps, of the order of 1 % of the critical mass. It is for these reasons that critical experiments must be done with caution and in specially-designed laboratories.

To extract information other than dimensions from critical experiments requires much more effort. It is necessary to evaluate the conditions particular to the experiment, the effect on the critical volume of the container or the supporting structure, for example. It is also desirable to measure the spectral and spatial distribution of the neutron flux within and adjacent to the assembly. It is necessary to know in detail the properties of the experimental materials — both fissile and those needed for the experiment — requiring chemical and isotopic analyses. Additional knowledge of the properties of the critical assembly may be obtained from its kinetic behaviour, that is, the time rate of change of the neutron population as a function of the perturbation which caused it. From many data can come an analysis of the experiment and correlation with a definitive theoretical model.

### *Neutron Multiplication Experiments*

The establishment of critical dimensions by neutron multiplication experiments, sometimes called 'critical approach' or 'subcritical' experiments, is a variation on the critical experiment described above. In these, as before, the test material, a source of neutrons, and a neutron detector are required. The same assembly procedure is followed, except that the assembly of material is stopped short of critical by an amount depending on the confidence in the measure of the multiplication. Many data obtained in laboratories from experiments of this kind have yielded valuable information on the critical dimensions through extrapolation of the reciprocal neutron-multiplication curve. The method has been used extensively in at least one process plant to determine the margin of safety in many operations.

In these experiments it is important to establish a truly representative reciprocal multiplication curve which can be extrapolated with confidence. This will require careful location of the components to ensure observation of a neutron count rate characteristic of the assembly and not one distorted by extraneous reflections from nearby structure. It is most desirable, for example, to place the source within the fissile unit.

Two applications of this type of experiment to process testing, made at the Rocky Flats Plant, are described here. The first problem, reported by Bidinger <sup>(1)</sup>, was undertaken to ascertain the feasibility of increasing the U 235 capacity of a storage tank by first filling the tank with short sections of borosilicate glass tubing known as Raschig rings. The experimental arrangement is shown in the upper section of Figure 1. The glass rings (3.8 cm long, 3.8 cm outside dia., 0.2 cm wall thickness, 12.5 % B<sub>2</sub>O<sub>3</sub> content) when packed in the tank occupied 17.8 % of the volume and established a boron density of 15.4 g/litre. The tank was surrounded by concrete to provide neutron reflection. The neutron source was placed in the lower part of the cylindrical tank and the neutron counters beneath it. Aqueous uranyl nitrate solution, containing uranium of about 90 % U 235 content, was used in these experiments at two chemical concentrations. The lower section of Figure 1 shows the results in a plot of the reciprocal neutron multiplication observed as solution was added to the tank. A balance between neutron leakage and neutron production after a particular height is exceeded is shown by the parallelism of the curves and the abscissa. This indicates that a tank infinitely tall will be subcritical.

The second example illustrates an examination of the safety of a storage array. The units to be stored were cylindrical containers of an enriched uranium solution mounted in a supporting frame. The neutron source was located inside the container which was to become the most central in the array and the boron-containing neutron detectors were placed at its base as shown in Figure 2. The result of assembling up to 25 conterminous units in a square pattern is shown in the graph. Figure 3 is a photograph of the completed array.

It is pointed out that this type of experiment does not yield basic information beyond the critical dimensions obtained from the extrapolation of the reciprocal multiplication curves. These remarks have been purposely detailed to emphasize the advantages of the method in a direct evaluation of process-plant safety.

#### *Material Replacement Experiments*

A low-power reactor or critical assembly is required for experiments of this type. The assembly is equipped with a device for precisely adjusting the reactivity and is provided with a means of introducing samples into a central region. It essentially compares the neutron multiplying properties of a test sample with those of a standard.

The properties of a number of materials have been studied extensively at the Hanford Laboratories by this method in the Physical Constants Test Reactor described by Donahue <sup>(2)</sup>. The PCTR may be briefly described as a graphite-moderated critical lattice of enriched uranium rods enclosing a central cavity having a capacity of a few hundred litres. The assembly is approximately a 2-m cube. It can be separated into two sections for operational convenience. Although the central cavity is filled with the test material, only a small portion at the centre is designated as the sample. The purpose of the remainder, called a buffer, is to establish at the sample a neutron spectrum characteristic of the test material itself in contrast to the spectrum in the critical uranium lattice. The property evaluated in the PCTR is the neutron multiplication factor of an infinite sample,  $k_{\infty}$ .

The basis of the experiment is the condition that exchange of two samples

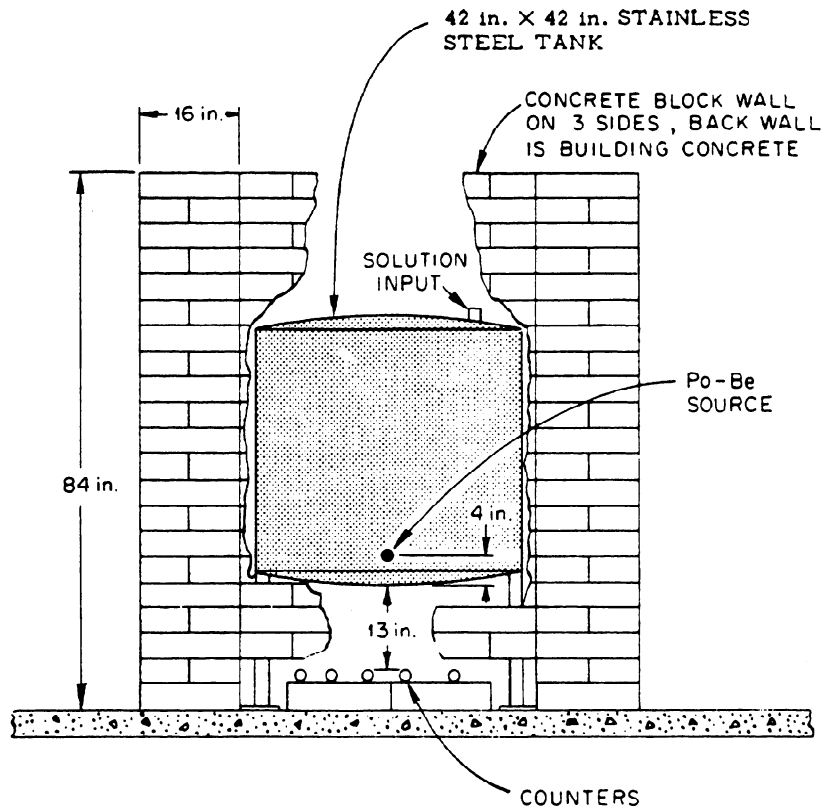

*Experimental tank set-up.*

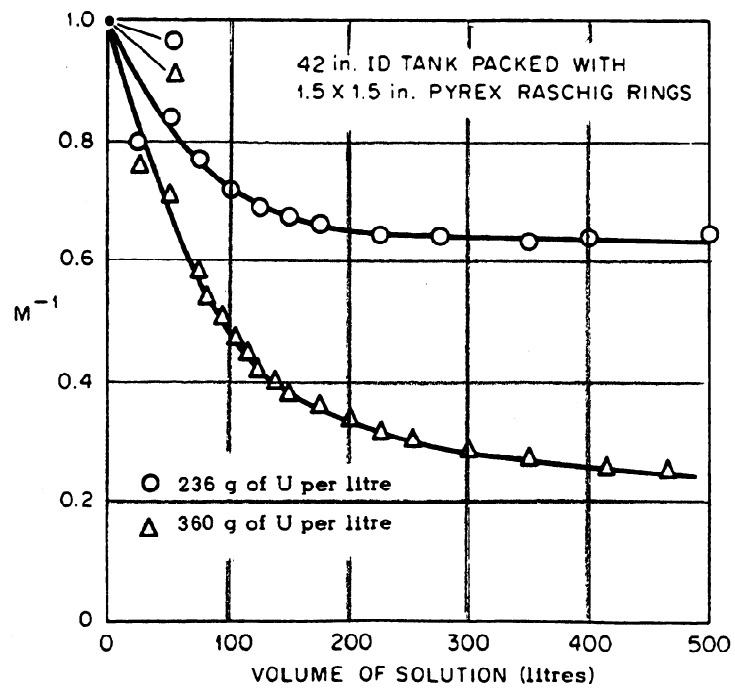

*Reciprocal neutron multiplication ( $M^{-1}$ ) as a function of  $UO_2(NO_3)_2$  solution volume in litres.*

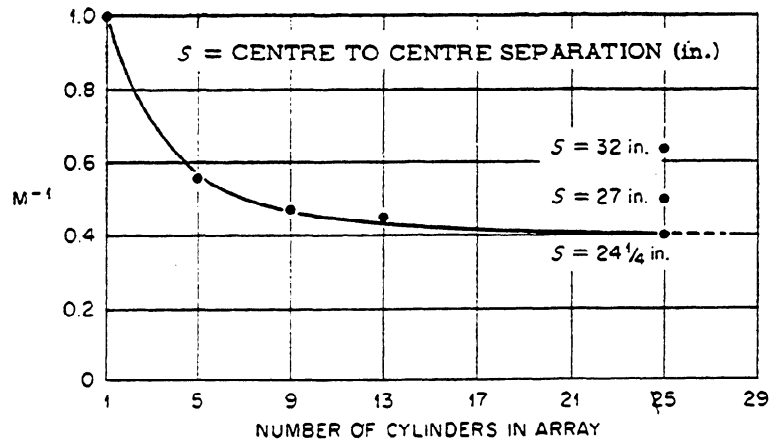

*Reciprocal multiplication as a function of number of cylinders in array.*

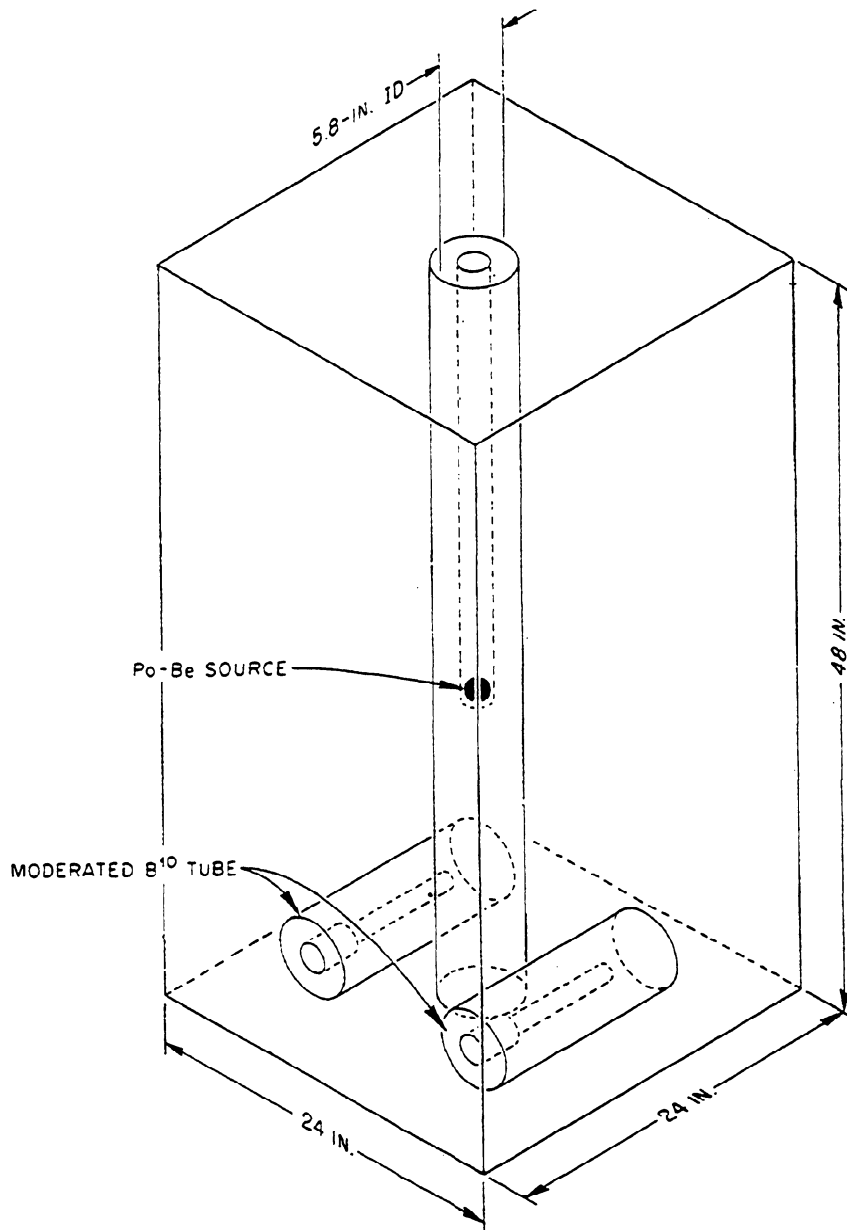

*Central source container.*

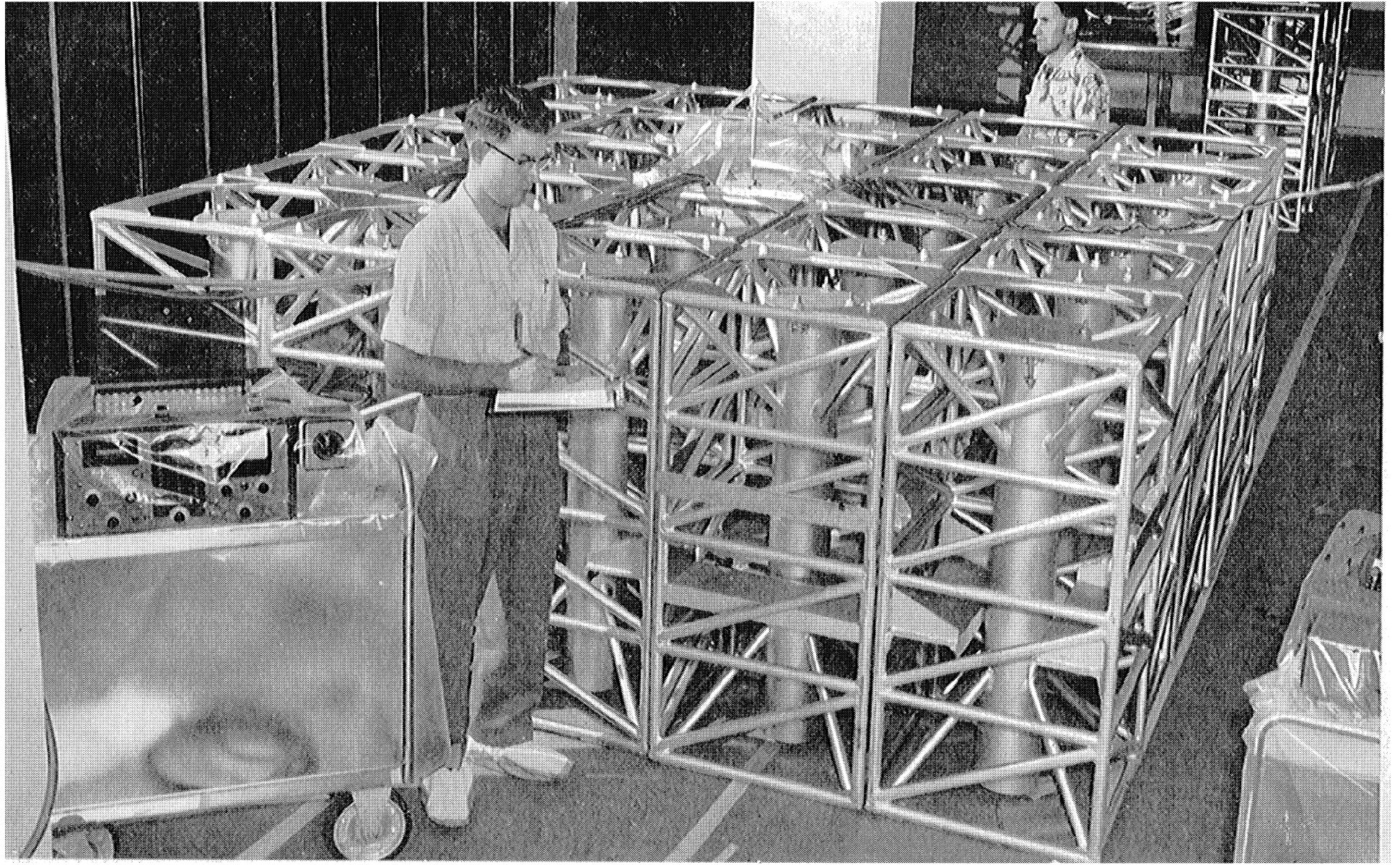

of equal  $k_{\infty}$  within the assembly will not change the reactivity of the assembly. In the PCTR experiments one of the samples, the standard with  $k_{\infty}$  unity, is a vacuum or, for practical reasons, helium. The procedure, therefore, is to adjust the amount of a neutron absorber, of known properties, distributed within the material under study, including the buffer, until substitution of the standard sample for the central poisoned test sample causes no change in the overall reactivity of the assembly. This condition is achieved, of course, when the control devices remain fixed for both sample conditions.

The value of  $k_{\infty}$  can be inferred from the quantity of neutron absorber required to establish this identity of samples and its neutron absorption cross-section.

Figure 4 is a photograph of the PCTR and Figure 5 is a close view of the buffer section. The test sample measured  $15 \times 15 \times 30$  cm.

The application of the PCTR is illustrated by the recent experiments by Handler<sup>(3)</sup> establishing the limiting critical U 235 enrichment of uranium homogeneously moderated by hydrogen. The test material was uranium oxide mixed with an hydrogenous plastic. The value of  $k_{\infty}$  was determined for each of several mixtures of varying hydrogen content over a range of U 235 enrichment. Interpolation of the results defined a combination of these quantities ( $\sim 1\%$  U 235 enrichment and an H/U ratio of about 5) which, without any extraneous neutron absorber, would effect no change in the reactivity of the assembly upon substitution for the standard.

### *Exponential Experiments*

Information describing neutron multiplying properties may be obtained from exponential experiments, an example of the type depending primarily upon neutron distribution measurements. Exponential experiments can be performed with considerably smaller quantities of the material of interest than are required for critical or even for multiplication experiments. An idealized exponential experiment consists of a block of the test material placed with its base adjacent to an extended source of neutrons. The source may be a beam of neutrons from an operating reactor or it may be one or more capsules of a mixture of polonium and beryllium, or of plutonium and beryllium, embedded in a neutron diffusing material such as graphite.

The performance of the experiment consists in measuring the steady state spatial distribution of slow neutrons in the multiplying medium with appropriate neutron detectors. The material buckling,  $B_m^2$ , a property only of the material, can be obtained from this distribution in the following manner. Neutron diffusion theory<sup>(4)</sup> relates the buckling and the slow neutron distribution by the expression:

$$\left(\frac{\pi}{a}\right)^2 + \left(\frac{\pi}{b}\right)^2 - \gamma^2 = B_m^2$$

In this relation  $a$  and  $b$  are the effective dimensions of the block in the plane parallel to the base and  $1/\gamma$  is the relaxation length of the neutrons in the direction perpendicular to the base. The relaxation length is the distance within which the neutron flux decreases by a factor  $e$ , the logarithmic base, as is seen from the expression  $\Phi(z) = Ce^{-\gamma z}$ , describing the exponential dependence of the flux on the distance from the source. The quantities measured in the experiment are  $a$ ,  $b$ , and  $\gamma$ . Recognition must be made of the deficiencies of diffusion theory in the interpretation of these measurements.



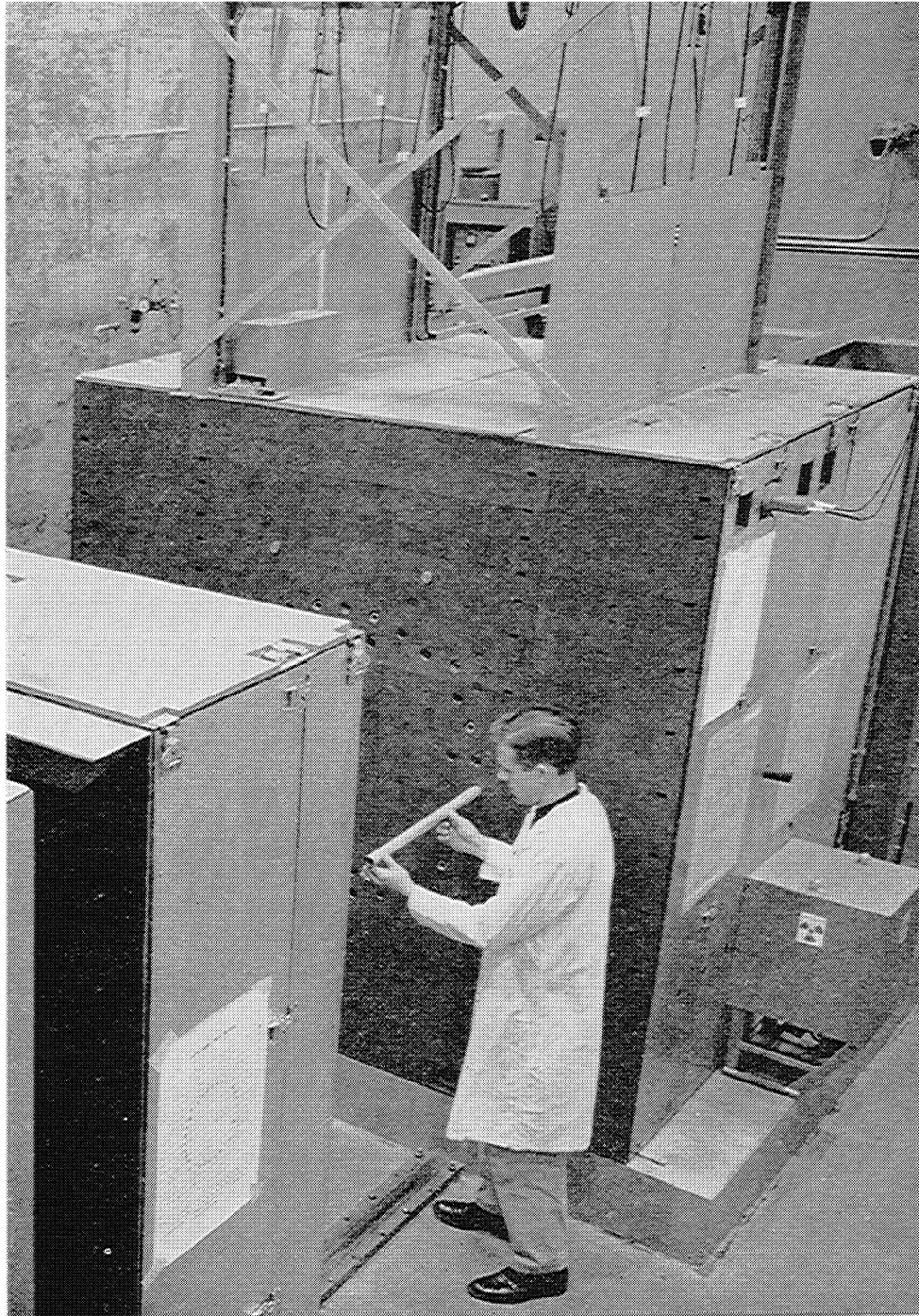

Figure 4. *Physical Constant Test Reactor.*

The solution of the equation describing the flux distribution in a particular critical assembly yields a value of the geometric buckling,  $B_g^2$ , a property of the geometry. Since the values of the geometric and the material



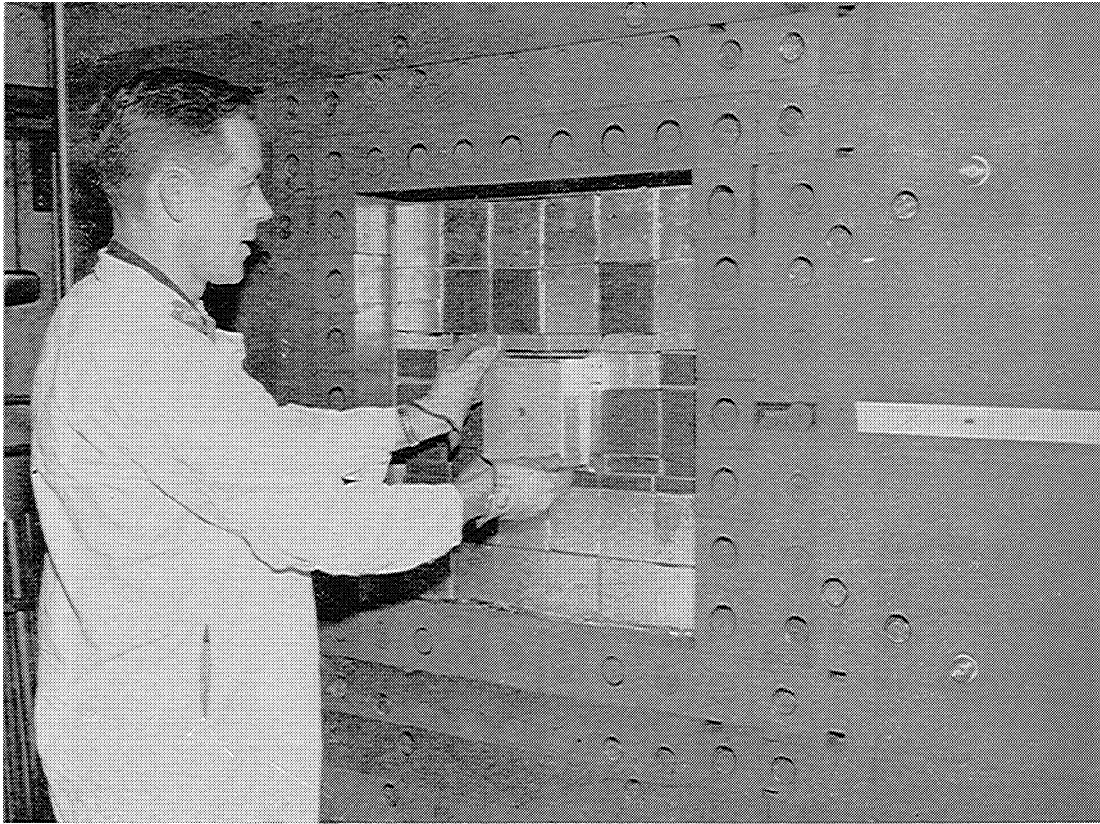

Figure 5. Close view of PCTR near midplane.

bucklings of a critical system are equal, determination of the latter from an exponential experiment enables the critical dimensions of the material in a particular geometry to be calculated by equating these two characteristic quantities. It is emphasized that dimensions appearing in the expressions for bucklings define a fictitious boundary where the neutron flux, not the physical boundary, effectively vanishes. These two dimensions differ by the extrapolation distance, a difficult quantity to evaluate since it depends in part upon the multiplying medium, the shape of the boundary and the reflector condition. Uncertainties in extrapolation distances can introduce significant errors in the critical dimensions evaluated in this manner.

Many exponential experiments have been described in the literature <sup>(5)</sup> and reference is made to them for details.

#### *Pulsed Neutron Experiments*

In the second type of experiment predicated on neutron distribution, short bursts of fast neutrons are injected into a sample of the multiplying material and the exponential decay of the prompt neutrons from fission is observed. Characteristic lifetimes in moderated multiplying media are of the order of milliseconds and are significantly less in fast neutron systems.

The prompt neutron decay constant governing the exponential decay is the quantity measured in pulsed neutron experiments.

Treatment of the time-dependent prompt neutron flux decay by reactor analysis relates the decay constant to the buckling of the medium. In principle the prompt critical buckling is the intercept obtained by extrapolation of the curve relating the measured decay constants of assemblies of a particular composition to their geometric bucklings. In some cases the delayed critical buckling can be inferred from the results of this type of experiment, supplemented by knowledge of the properties of the material.

The equipment required for these experiments includes a source of fast neutron pulses and a neutron detecting system capable of measuring the neutron intensity as a function of time within intervals in the 0.01  $\mu$ s to millisecond range. The source is usually the D-T nuclear reaction which yields 14 MeV neutrons. A beam of deuterons, accelerated by potentials of the order of 100 kV by a high voltage device, is caused to fall upon a tritium target only during short periodic intervals by a pulsing electrostatic field through which the beam passes. Equally short and periodic bursts of neutrons are thereby produced. Neutrons are detected by crystal scintillators. The time distribution of the neutrons following a burst is measured directly or is converted to a pulse-height distribution which is sorted into intervals by a pulse height analyzer. The output of the analyzer is stored until the number of pulses observed is sufficient for adequate statistics. The original distribution in time is then displayed.

A number of pulsed neutron experiments have been reported and reference is made to them for details of the analyses <sup>(6)</sup>.

That quantitative measures can be made of process equipment sufficiently subcritical to meet safety requirements has not been clearly established. A proposal for effecting such measurements has been made by Silver <sup>(7)</sup> in which the decay constant is first determined with the equipment water-filled, and then when filled with a solution of known concentration of fissile isotope. A linear extrapolation of these two points yields the concentration which would be prompt critical and an estimate can be made of the delayed critical concentration. Values of the decay constant measured during subsequent operations indicate the degree of approach to a potentially hazardous condition. Favourable comparison of the values of  $k$  describing an assembly of water-moderated and reflected reactor fuel elements obtained both by a pulsed neutron experiment and by a more conventional method support the proposal. The minimum value of  $k$  in this experiment was 0.87.

This technique, in its present development, is applicable to homogeneously distributed materials in simple geometry.

The availability of compact portable sources of neutron pulses makes desirable an exploration of this method of safety evaluation.

#### LABORATORY AND EQUIPMENT REQUIREMENTS

Any experiment with fissile material is potentially hazardous to a degree depending upon the nearness of the approach to criticality in its performance. The experiments considered above, therefore, require specialties in laboratory and equipment design commensurate with both the radiation hazard involved and the possible severity of radioactive contamination arising from the test materials. Brief comment on accepted practices will be made in this Section.

### *Critical Experiments*

Of the several types discussed, critical experiments are more vulnerable to nuclear incidents. In fact the record in the United States shows a greater preponderance of incidents of this kind in critical experiments laboratories than in all other nuclear activities combined. This susceptibility is not unexpected, because these experiments are purposely exploratory and because they are short-ranged and do not warrant the detailed operational mechanisms prepared for long-term operating reactors. On the other hand, although incidents in critical experiments may be quite severe in their immediate environs, the hazard to an extended area is negligible since, in low-power operation, no inventory of radioactive fission products has accumulated. For these reasons the critical experiments laboratory is designed to protect primarily the operating staff. This protection against direct radiation is provided by local shielding or by adequately separating the potential accident site from the operating centre. Both of these methods must be supplemented by control of personnel to ensure their proper location at times of accident potential. This control may be accomplished by interlocking equipment with access barriers and by strict administrative practices. Potential accidents necessitate these protective measures, not the usual low-power operations.

The Los Alamos Laboratory is admirably located in a system of connecting canyons which allows the 'safety-by-distance' solution of the radiation problem. A plan of the laboratory site is shown in Figure 6. The experiments, assembled in buildings designated as kivas, are made critical by remote operation from the control centre some 400 m distant. Natural shielding provides protection of one kiva from the other. Requirements of long cables for instrument and control signals and inconvenient access by personnel for equipment adjustment are obvious disadvantages of this laboratory plan.

The recently completed Plutonium Critical Mass Facility at Hanford described by Reardon and his colleagues<sup>(9)</sup> is an example of a laboratory with test and control areas relatively proximate and radiation protection provided by local shielding. The reactor room walls and the roof are of ordinary reinforced concrete 1.5 m and 0.6 m thick, respectively. The structure is designed to provide protection both from the radiation accompanying a nuclear excursion and any concomitant internal pressure. Figure 7 is the floor plan of the facility of which Figure 8 is an exterior photograph.

Special equipment is required in some laboratories to contain contaminating materials which may be used in their programmes. Figure 9 is a photograph of a compartment to house the vessels in which the plutonium-solution critical experiments will be performed.

The basic requirements of the equipment for critical experiments can assume many variations in conformity with the needs of particular assemblies. The requirements, succinctly enumerated, are: a neutron source, three or more neutron detectors, and a method of changing the reactivity of the assembly by remote control.

The source can be a capsule containing a mixture of polonium and beryllium, plutonium and beryllium, or radium and beryllium, although the gamma radiation from radium is undesirable. The neutron source may be an inherent property of the test material exemplified by spontaneous fission in U 238 and in Pu 240, a contaminant of Pu 239; or by the  $\alpha$ - $n$  reaction on the oxygen in aqueous solutions of plutonium, a strong alpha particle emitter.

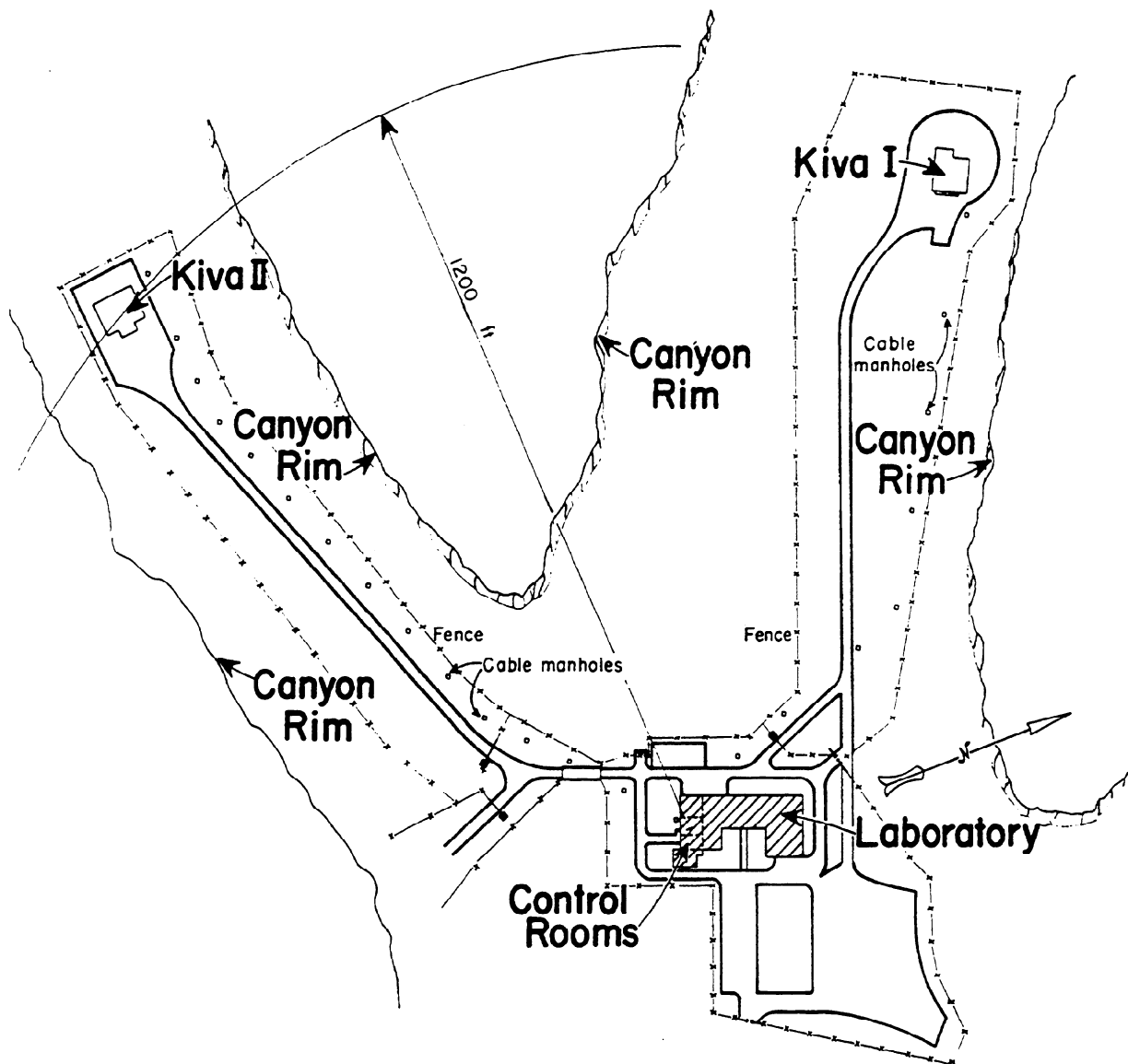

Figure 6. Plan of Los Alamos critical experiments laboratory site.

Although a proportional neutron counter, with associated amplifier and scaler, is required for observing the source-neutron multiplication in the approach to criticality, operation both at and near critical can be best guided by a continuous recording of the output of an integrating device such as an ionization chamber. Two or more of the sensory circuits, preferably of very rapid response, are required to signal an emergency and to actuate the shut-down mechanism if a predetermined power or neutron flux level is exceeded. A safety circuit responsive to the time rate of change of the flux level is a desirable supplement.

Auxiliary necessities are standard health physics-type instruments for the control of contamination which can arise from the materials under test, and for radiation surveys both during normal experimentation and in the event of an incident.

The details of the method of controlling the reactivity may vary widely,

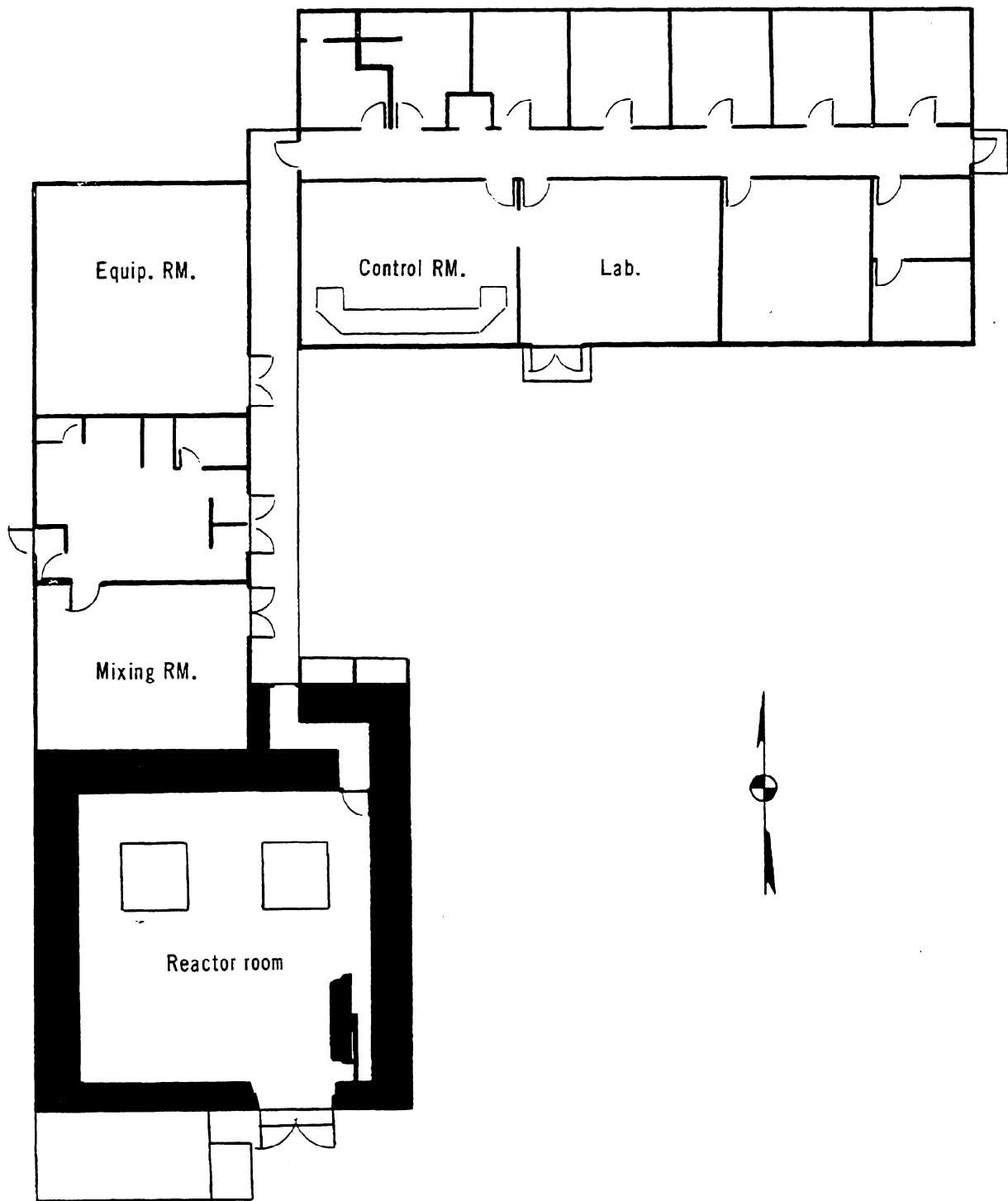

Figure 7. Floor plan of Hanford plutonium critical mass facility.

depending upon the nature and the materials of the experiment, provided two basic requirements are met. One of these requirements is remote operation and the other is, in effect, reversibility of the operation with the rate of reactivity removal greater than the rate of addition. At this point the discussion may diverge along many paths. Possibly the simplest example, and one often employed, is the stepwise construction of an array in the presence of a

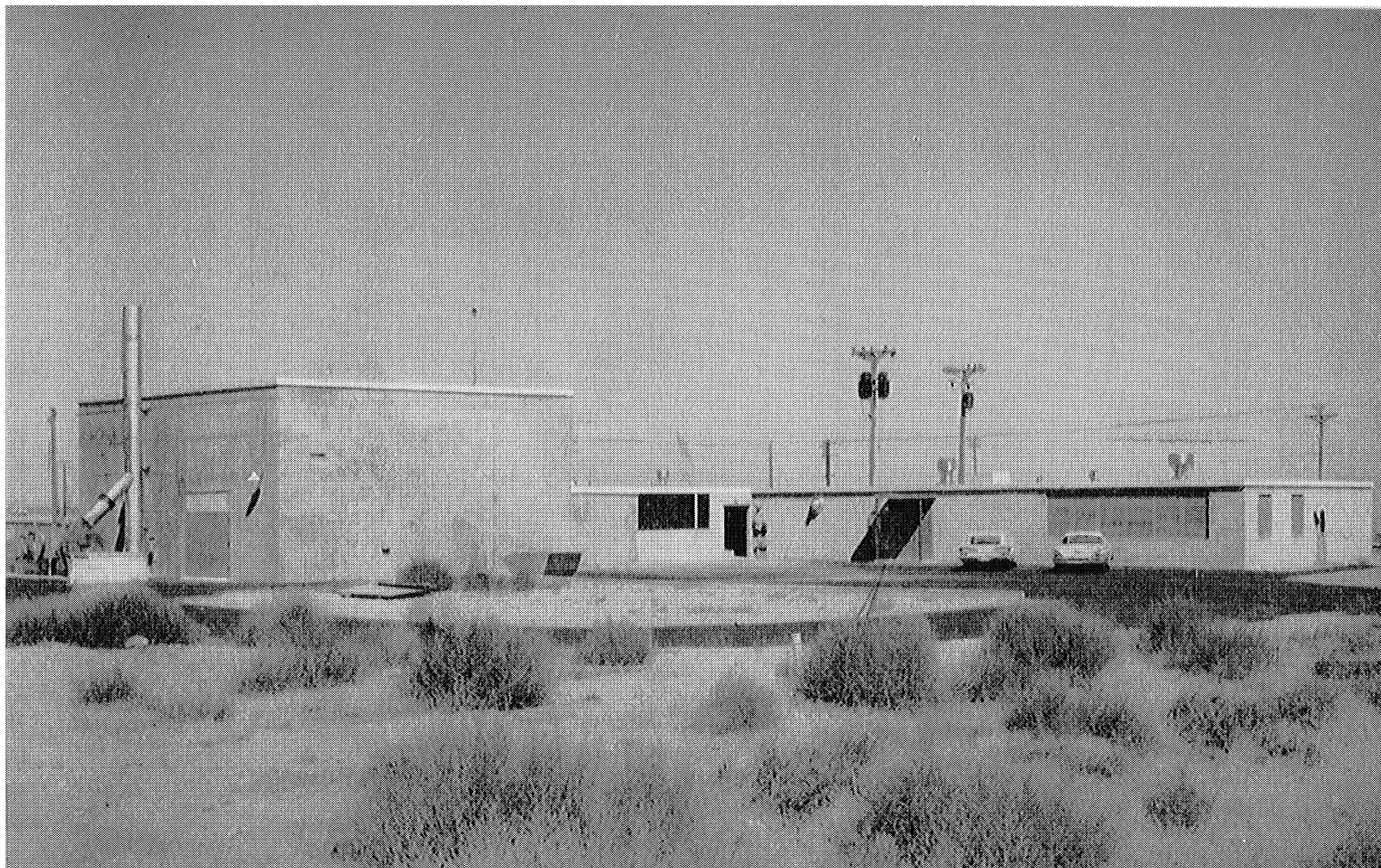

Figure 8. *Exterior of the Hanford facility.*



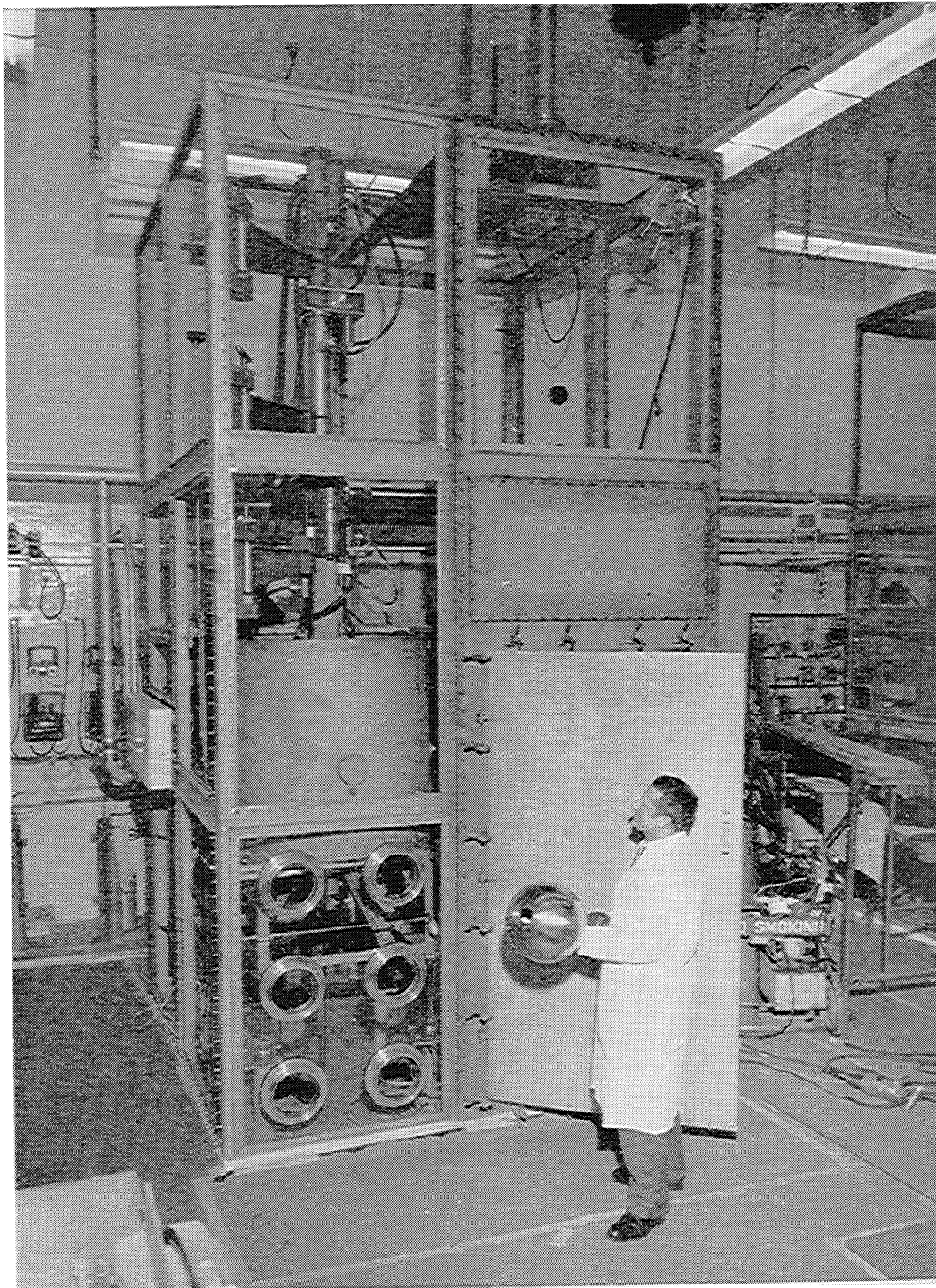

Figure 9. *Containment structure for plutonium critical experiment equipment.*

strong neutron-absorbing element which can be withdrawn by remote control. If, further, this absorber is supported against gravity by an electromagnet whose current is controlled by the radiation-sensitive detectors, its reinsertion serves the shut-down requirement.

A well known method of reactivity control in experiments with solid

materials is the construction of the assembly in two sections, one being movable by a remotely-operated motor. Upon emergency signal the sections are driven apart at a speed greater than their approach. A remotely-operated pump may transfer a liquid to the experiment — for example the fissile material in solution or an aqueous neutron moderator or reflector for a solid-fuel system. Removal of the liquid can be through a pipe, larger than the entry line, equipped with a 'normally-open' valve controlled by the radiation sensor. It is appropriate to provide a second and independent shut-down method to guard against the failure of the primary one. This may also be the insertion of an absorber, or the removal of moderator or fuel, by gravity or by a spring-loaded device. Many effective and acceptable combinations of these basic control methods can be devised.

It is difficult to illustrate the details of actual experimental arrangements. The assembly for each of two recent tests made in Oak Ridge are shown in Figures 10 and 11. In the first of these the material mounted on the platforms is a mixture of  $UF_4$  and paraffin formed into compact blocks and wrapped in thin aluminium foil to facilitate handling. The platform on the left is movable by controls located in a well-shielded area. The approach to criticality is effected by observing the neutron multiplication as successive blocks are added. The base is a low density aluminium structure to minimize the return of neutrons in this nominally unreflected array.

A photograph of an array of 98 plastic bottles containing 93% U 235 enriched uranium in solution (Figure 11), is even less definitive of detail. The purpose of the experiment was to establish safety specifications for storage of these units, each of which contained about 6 kg U 235, by determining the critical number as a function of their spacing. Although the contents of most of the units remained fixed during the experiment, five centrally located units were joined to a common supply of solution and could be filled by a remotely-operated pump. They could be emptied through a large pipe fitted with an automatically controlled valve. It is, perhaps, obvious that this experiment followed many simpler ones which established the critical dimensions of smaller arrays.

### *Neutron Multiplication and Exponential Experiments*

There are no unique laboratory requirements imposed by safety on neutron multiplication and exponential experiments. Fissile materials and neutron sources are used in both, so it is imperative that the quantities of the former be kept well below critical amounts and that the hazards of neutron sources, *per se*, be recognized. If the assemblies under study are nominally unreflected, it is necessary that they be located with reasonable separation from extraneous reflecting structures.

The instrumentation for the neutron multiplication experiments is the same as that required for the initial steps of a critical experiment.

### *Pulsed Neutron Experiments*

The above comments on quantities of fissile material and neutron reflection are applicable to pulsed neutron experiments with perhaps even greater emphasis on minimizing spurious neutron reflection. Personnel shielding during these experiments is necessary because of the intensity of the neutron source.



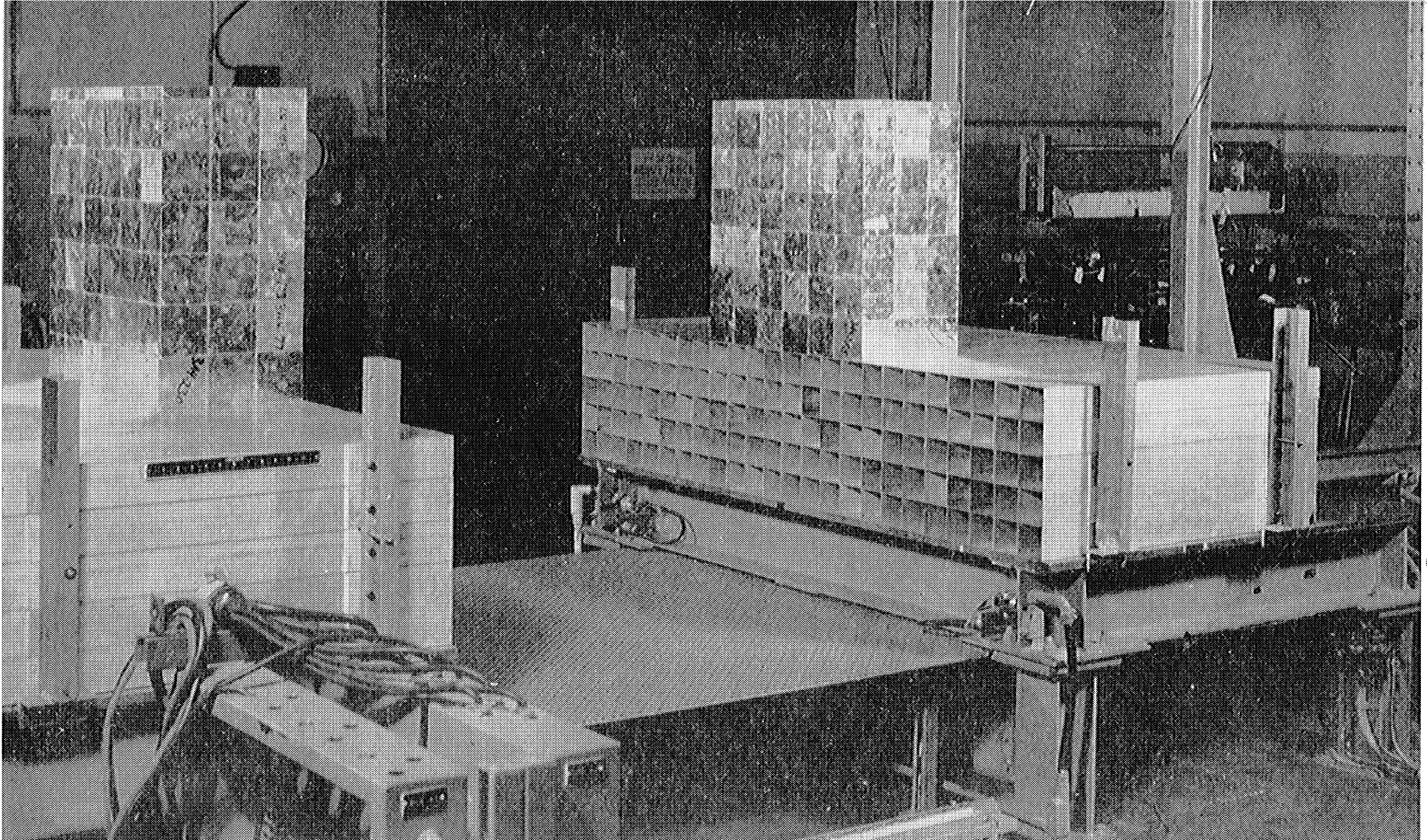

Figure 10. *Assembly of solids containing U 235-enriched uranium on separable table.*

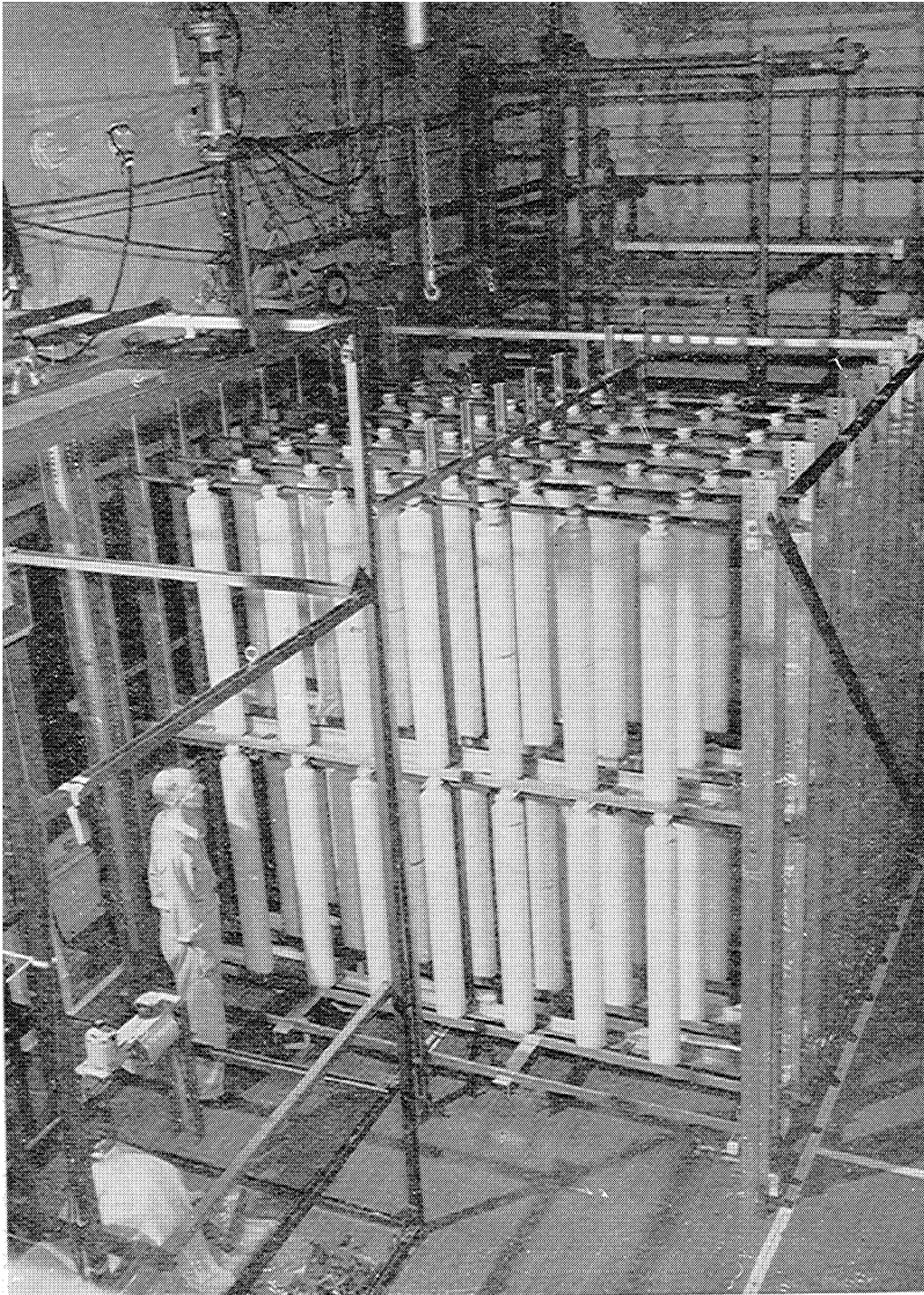

Figure 11. *Array of U 235-enriched uranium solution containers.*

#### PERSONNEL REQUIREMENTS

Little need be said about the qualifications of personnel for these experiments beyond pointing out that each is a research type project requiring qualified and knowledgeable staff. The performance of critical experiments is

not to be likened unto the operation of a power reactor. Most reactors are well-established machines incorporating thoroughly tested safety devices and automatic control mechanisms whose surveillance can be made a routine.

#### FUTURE DEMANDS ON EXPERIMENTS

There are deficiencies in the basic information applicable to nuclear safety problems. It is the intent of this Section to list some of those areas in which deficiencies are believed to exist; the selection is based on personal observations and is not purported to be complete.

##### *Enriched Uranium*

1. Perhaps the most interesting and demanding gap in the data at this time is the dependence of critical parameters on the density of U 235 in process materials. Although the mass of U 235 per unit volume of solution is established by solubility, the mass per unit volume of a slurry of a sintered oxide, whose density is nearly that of the crystal, will be significantly different at the same moderation. Experiments performed with high density compounds, highly enriched in U 235, compacted homogeneously with hydrogenous solids, will furnish information on this density effect.

2. The relation between critical dimensions of standard-density, highly-enriched uranium compounds as a function of moderation should be extended to zero moderation.

3. Another area, at present under investigation but requiring extension, is that of arrays of individually subcritical units. To generalize even a semi-empirical interpretation of data and to provide for development of a theory requires knowledge of the effect on a critical array of the following:

- a) The moderation of a single unit;
- b) The U 235 density and the U 235 enrichment of a single unit;
- c) Neutron reflectors closely fitting single units;
- d) A moderator distributed between units;
- e) The reflection of the array.

4. The knowledge of uranium of intermediate enrichment should be broadened by repeating item 1 with 30 % U 235 material.

5. The field of low enrichment should be extended by repeating both items 1 and 2 with 5 % enriched uranium.

6. Very little is known of the properties of enriched uranium moderated by other than hydrogenous materials. Suggested for study as moderators are: D<sub>2</sub>O, D<sub>2</sub>O-H<sub>2</sub>O mixtures, beryllium and carbon. The last two, in combination with water or organic substances, will yield information useful in some reactor fuel fabrication processes. Common organic materials encountered in industry may be included in this list.

##### *U 233 and Plutonium*

It is believed that only the more basic information describing U 233 and Pu 239 is required and that effects on attendant criticality problems of special moderators, etc., and the interaction between subcritical units can be extrapolated from U 235 data with support from a few representative measures. The topics suggested are, therefore:

- a) The critical dimensions of water-reflected and unreflected spheres of aqueous solutions in an H/U 233 range of 70 to 1,000;
- b) A study of H/U 233 values between 0 and 50;
- c) Examination of U 233-Th mixtures;
- d) An extensive programme yielding basic information describing Pu 239, in simple geometry, over a wide moderation range including H/Pu 239 of 0 to 50.

### *Mixed Fissile Isotopes*

The critical dimensions of binary and ternary mixtures of U 233, U 235 and Pu 239 will be useful to some applications.

### *Neutron Absorbers*

Investigations furthering the use of neutron-absorbing elements as either liquid or solid constituents of process streams will support this method of increasing unit capacity. Distinction should be made between the effect of a solid constituent as truly an absorber, and its effects as a diluent and in producing inhomogeneity.

### *Experimental Methods*

Improvement can be made in existing experimental techniques and in developing practical in-process methods of evaluating nuclear safety. An example is the application of pulsed neutron experiments.

## ACKNOWLEDGEMENTS

Appreciation is expressed to D. Clayton, H. Paxton and C. L. Schuske for descriptions of experimental facilities at Hanford, Los Alamos and the Rocky Flats Plant, respectively.

## REFERENCES

1. G.H. BIDINGER, C.L. SCHUSKE and D.F. SMITH, "Nuclear Safety Experiments on Plutonium and Enriched Uranium Hydrogen-Moderated Assemblies Containing Boron", *RFP-201* (1960).
2. D.J. DONAHUE, D.D. LANNING, R.A. BENNETT and R.E. HEINEMAN, "Determination of  $k_{\infty}$  from Critical Experiments with the PCTR", *Nucl. Sci. Eng.* 4, 297 (1958).
3. H.E. HANDLER, "Nuclear Physics Research Quarterly Report", *HW-54591*, p. 41 (Dec. 1957).
4. For details of exponential experiments the reader is referred to any treatise on reactor theory, for example: A.M. WEINBERG and E.P. WIGNER, *The Physical Theory of Neutron Chain Reactors*, p. 428-431, The University of Chicago Press, 1958; S. GLASSTONE and M.C. EDLUND, *The Elements of Nuclear Reactor Theory*, p. 281. Van Nostrand, New York, 1952.
5. For a review of early experiments and descriptions of their use see: D.E. DAVENPORT, "Exponential Experiments on Graphite Systems", in *Proc. First. U. N. Int. Conf. Peaceful Uses Atomic Energy. Geneva, 1955*, 5, 309.  
H. KOUTS and R. SHER. "Experimental Studies of Slightly Enriched, Water-Moderated Lattices", *BNL-486* (1957).

6. For example see: E.C. CAMPBELL and P.H. STELSON, " Physics Division Semi-annual Progress Report ", *ORNL-2204*, p. 34 (Sept. 1956).  
F.A. KLOVERSTROM and T.T. KOMOTO, " Pulsed Neutron Source Studies of Graphite-Enriched Uranium Systems ", *UCRL-5477* (1959).  
A more extensive discussion is given by: G.F. von DARDEL and N.G. SJOSTRAND, *Progress in Nuclear Energy, Series I, Physics and Mathematics*, V. 2, p. 183, Pergamon Press, London, 1958.  
A survey of the use of pulsed neutrons in reactor studies was presented at the International Accelerator Conference in Amsterdam. See: K.H. BECKURTS. " *Nucl. Instr. Methods*, 11, 144 (1961).
7. E.G. SILVER, " A Proposal for Criticality Control Measurements Using Pulsed Neutron Methods ", *CF-60-5-130* (1961).
8. W.A. REARDON *et al.*, " Hazards Summary Report ", *HW-66266* (Aug. 1960).

\*  
\* \* \*

## DISCUSSION

G. BLÄSSER, Euratom:

Je serais heureux de savoir si l'on peut lire les variations du niveau de la cuve du réacteur PROSERPINE à 0,01 mm près ou 0,1 mm, ainsi qu'il est dit ailleurs dans le rapport de M. Clouet d'Orval. Je me demande également si la quantité de solution qui reste toujours dans le réservoir pour des raisons de capillarité n'introduit pas une erreur dans la détermination de la hauteur critique de la cuve.

C. CLOUET D'ORVAL, France:

Nous pouvons effectivement apprécier des variations de hauteur de 0,01 mm. Le tube qui traverse l'empilement et reste rempli de solution contribue bien sûr à la masse critique de l'ensemble. Nous n'avons pas pu en déterminer correctement l'effet, mais nous pensons qu'il est faible.

W. SCHÜLLER, Eurochemic:

I was surprised to hear from Mr. Walford that concrete is a better reflector than water. Could he specify whether there are any results and to what cases this applies?

J.G. WALFORD, United Kingdom:

We have carried out only one main type of experiment on the effectiveness of concrete as a neutron reflector; this made use of a 1.4 % enriched uranium system of near-optimum moderation. We found that water gave a reflector saving to this system of about 3.5 cm whereas the reflector saving due to thick concrete was almost 5 cm. I would not like to suggest that these figures are directly applicable to any other system. I do believe, however, that our experiments place the various reflectors in the correct order of effectiveness, at least for thermal neutron systems, and the high neutron reflecting power of concrete should therefore be seriously considered when assessing the safety of process vessels.

C. SCHUSKE, United States:

What H/X ratio were these systems?

J.G. WALFORD:

The comparison of concrete and water as reflectors was mainly carried out on solid near-cubical assemblies of 1.4 % enriched uranium at an H/U (total) ratio of 8, corresponding to an H/U 235 ratio of about 570. This system is well moderated. The slide showing the interacting slab experiments depicts a system which will first be used with 30 % enriched uranyl fluoride solutions having an H/U 235 ratio of about 130, which we find is near the moderation giving minimum critical volume.

D. CALLIHAN, United States:

We obtained very provisional data on a 3 %-U 235 enriched uranium, hydrogen-moderated system at an H/U 235 of about 130. An 18-in. thickness of concrete seems to be a slightly better reflector than a similar thickness of paraffin, which in turn is a slightly better reflector than an equal thickness of water. With thinner layers of the individual materials, this relation might be somewhat different. I point out further that these results are strongly dependant upon the material being reflected.

P. BENOIST, France:

Que penserait M. Walford de l'explication suivante sur l'efficacité du béton, de l'eau et de la paraffine comme réflecteur : étant donné que les fuites de neutrons dans un système aqueux sont essentiellement des fuites de neutrons rapides, la présence dans le béton d'éléments lourds pourrait ralentir la thermalisation des neutrons dans le béton ; il en résulterait qu'un neutron rapide aurait une chance moindre de devenir thermique dans le béton et d'être capturé par la forte section efficace de l'hydrogène ; en d'autres termes, il aurait donc une chance plus grande d'être renvoyé dans le cœur.

J.G. WALFORD:

We in the United Kingdom, agree very much with what Mr. Benoist has just said. I did not wish to imply that we were completely without an explanation of the effect when I mentioned it as a side-issue from the experimental programme, but rather to suggest that it is one of those things that have perhaps been glossed over slightly in the early, more simplified treatment of criticality problems.

E.R. WOODCOCK, United Kingdom:

The fact that concrete is a better reflector than water can be roughly explained in this way. The concrete contains more atoms heavier than hydrogen than does water. These heavier atoms will turn a neutron back to the core much more easily than hydrogen will, because scattering with hydrogen in a laboratory system is always forward. We know that, in many cases, the thermal neutrons returning to the core are more effective than the fast neutrons returning to the core, but in concrete it seems that the actual number of neutrons returned is the overwhelming factor.



J.G. WALFORD:

I think this may be one of quite a number of instances where even a relatively crude experimental measurement can point the way to a more elegant theoretical treatment which can in its turn explain the phenomenon. Sometimes the more subtle phenomena tend to be overlooked in the rush of other computational work until some experimental evidence has been obtained.

R. GALLEY, France:

M. Walford a déclaré, au cours de son exposé qu'il était enclin, selon son opinion, qui est également celle de ses collègues, à recommander aux ingénieurs l'empoisonnement par différentes formules de poison, plutôt que des mesures pouvant porter sur la masse, la concentration, etc. Il a noté que ses suggestions relatives à cette forme d'action sur les masses critiques ne suscitaient que très peu d'enthousiasme. Ce manque d'intérêt ne serait-il pas partiellement imputable au fait que la plupart des gens ignorent la redoutable efficacité des poisons par suite de la rareté des connaissances diffusées à ce sujet ?

D. CALLIHAN:

I do believe that what Mr. Galley says is entirely true. In this new approach to safety, however, there is much to be learned about the effectiveness of the materials as neutron absorbers but more particularly much has to be learned about their integrity, their chemical and mechanical stability, and since this practice is new, I think it is being correctly applied with caution.

J. GUNTHER, France :

Je me demande également si le scepticisme qui règne vis-à-vis de l'emploi des poisons n'est pas dû au fait que leur efficacité est surtout portée vers l'augmentation de la masse critique et ne joue pas beaucoup, ou du moins à un degré qui n'a pas été précisé, sur l'élargissement de la géométrie critique. Or, la tendance actuelle est de contrôler le plus possible par la géométrie, de sorte que l'existence d'une masse critique plus grande n'apparaît peut-être pas, à de nombreuses personnes, comme un gain manifeste. Il est certain que l'effet d'un poison neutronique est beaucoup plus sensible dans des solutions très bien modérées qui donnent justement les masses critiques minima, alors que, pour les solutions peu modérées, l'effet des poisons dont l'absorption n'est sensible que dans le domaine thermique présente évidemment un intérêt beaucoup plus restreint.

E.C. WOODCOCK:

With regard to the graphs of experimentally measured multiplications shown by Dr. Callihan, I wonder if I may be forgiven for saying one general word about multiplication. Essentially a multiplication is measured by placing a neutron source at some point near or in the system and measuring a flux at some different point, and it is the ratio of this neutron flux to neutron source which gives us a measure of multiplication. This means that there are as many different multiplications as there are pairs of points at which one can put the source and counter. Some of these multiplications are very well behaved

and some are not; the surface multiplication of which I have spoken is one of the former. It is a measure of the skill of the experimenter, that he can place his source and counter in such a position that he gets a well-behaved multiplication which can extrapolate reliably to the critical size, but it is quite possible to place the source and counter in such a position that a most misleading multiplication is obtained. One may get very little effect until the system is very close to critical and then one will get a curve such as Mr. Callihan showed, which suddenly dropped down to the axis. This is perhaps a word of warning which should be borne in mind.

D. CALLIHAN:

As an experimentalist I showed that misbehaving multiplication curves can be obtained, and my remark was cautionary.

A.F. THOMAS, United Kingdom:

I agree thoroughly with both Dr. Callihan and Mr. Woodcock that one has to be very cautious about these things. At Aldermaston, we normally try to measure the central source multiplication of the system which is a very well-behaved quantity: but we feel that if one is going to measure multiplications other than the central source multiplication, or even central source multiplication itself, one must try to get the physics right. We believe that the multiplication to be used as an index of criticality is the ratio of the flux with the fissile material present to the flux with non-fissile replica. One is then measuring a ratio, and things like scattering, transmission of reflectors, etc., become a second-order effect — except with reflectors like water.

J.G. WALFORD:

I agree entirely with the points made by the last three speakers. The fact that the central source multiplication is one of the very few measures of multiplication which is well behaved is one of my reasons for having an objection, perhaps rather biased, to multiplication measurements as a class; this is that in order to use a central source you have of necessity lost the clean geometry you desire, which is a system without a space for a central source. Compensation for the source cavity is possible but is itself a potential source of error.

E.D. CLAYTON, United States:

In all these multiplication measurements people usually use at least three different counters or neutron detectors and these are placed at different positions with respect to the assembly, so that experimentally we are never in a position where we have to rely on one counter or one so-called multiplication, but have multiple curves which must all indicate the same critical mass, as it were; usually that curve is used which predicts the smallest critical mass during the approach.

H.C. PAXTON, United States:

I might mention that we are in the somewhat ridiculous situation of using central source multiplication as a safety index in our own regulations. In the older days when our work was confined almost entirely to fast neutron



systems, this was not so bad; central source multiplication of ten meant three-quarters of the critical mass, all within perhaps  $\pm 5\%$  limits. This is no longer the situation, but we have not learned how to write simple regulations in any other terms and to us the multiplication of ten means 75 % of the critical mass regardless of how the latter is established. There are some real problems where one is given a fixed fissile object and asked how safe it is to handle. One can only judge on the basis of multiplication measurements and, as Mr. Thomas has mentioned, the required replica becomes a very awkward thing where there is any hydrogenous material present.

P. BENOIST:

Il me paraît intéressant de noter que la méthode de substitution progressive de Bacher et Naudet, qui est utilisée en France depuis plusieurs années pour l'expérimentation sur des réseaux au graphite et à eau lourde et qui a fourni des résultats très satisfaisants, pourrait être utilisée également pour la détermination du "buckling" dans des solutions aqueuses thermiques. Il me semble en effet que l'interprétation de cette méthode de substitution doit être plus facile en milieu homogène qu'en milieu hétérogène par suite de la disparition des effets d'anisotropie, d'une part, et de la disparition des effets dus à l'écart par rapport à la symétrie de révolution, d'autre part.

PUBLICATIONS DE L'O. C. D. E.  
Dépôt légal n° 906 - 4<sup>e</sup> trim. 1961  
2, rue André-Pascal, Paris XVI<sup>e</sup>  
N° 13.742



*IMPRIMÉ EN FRANCE*