

X-Sender: u098222@cic-mail.lanl.gov
X-Mailer: QUALCOMM Windows Eudora Pro Version 4.2.2
Date: Fri, 03 Mar 2000 10:01:02 -0700
To: barbara henderson <bdh@lanl.gov>
From: Jack Carter <jxxc@lanl.gov>
Subject: Re: AECD-4240

<http://www.ntis.gov/ordering.htm>

Barbara,

We do not have a copy of AECD-4240 but you can (theoretically) order the report from NTIS. Ordering info at the above Web site.

(I say theoretically because NTIS destroys reports that are not money makers).

If you do not find it at NTIS, we can order it from OSTI but it will take a couple of weeks.

Jack
7-4446

At 08:42 AM 3/3/00 -0700, you wrote:

Thanks, Jack. What we hope (and desperately need) is that you can locate a copy for us. Thanks for your efforts. Barb

At 05:11 PM 03/02/2000 -0700, you wrote:

>0071755 NSA Accession Number: NSA-11-010272

> Title: BOOBY TRAPS
> Author(s): Paxton, H.
> Corporate Source: Los Alamos Scientific Lab., N. Mex.
> Publication Date: 1957 Page(s): 18
> Primary Report No.: AECD-4240
> Note: Decl. June 18, 1957
> Journal Announcement: NSA11
> Availability: NTIS
> Document Type: Report
> Language: English
> Contract No.: W-7405-ENG-36
>
>Barbara,
>
>I got a note that you need the citation for AECD-4240. Hope this is what
>you wanted, if not please let me know.
>
>Jack
>Research Library
>7-4446

Barbara D. Henderson, D.Min.
Los Alamos National Laboratory
ESH-6, Nuclear Criticality Safety, MS F691
Technical Information Specialist
P.O. Box 1663
Los Alamos, NM 87545
phone: 505/667-4789
fax: 505/665-4970
email: bdh@lanl.gov

X-Sender: u098222@cic-mail.lanl.gov
X-Mailer: QUALCOMM Windows Eudora Pro Version 4.2.2
Date: Thu, 02 Mar 2000 17:11:33 -0700
To: bdh@lanl.gov
From: Jack Carter <jxxc@lanl.gov>
Subject: AECD-4240

0071755 NSA Accession Number: NSA-11-010272
Title: BOOBY TRAPS
Author(s): Paxton, H.
Corporate Source: Los Alamos Scientific Lab., N. Mex.
Publication Date: 1957 Page(s): 18
Primary Report No.: AECD-4240
Note: Decl. June 18, 1957
Journal Announcement: NSA11
Availability: NTIS
Document Type: Report
Language: English
Contract No.: W-7405-ENG-36

Barbara,

I got a note that you need the citation for AECD-4240. Hope this is what you wanted, if not please let me know.

Jack
Research Library
7-4446

UNCLASSIFIED

THIS DOCUMENT CONSISTS OF 18 PAGES (S)

AECD-4240

CLASSIFICATION CANCELLED
 DATE 6-18-57
 by The Atomic Energy Commission
H. F. Canale
 met Declassification Branch *fm*

BOOBY TRAPS

Pittsburgh Meeting of American Nuclear Society
June 12, 1957.

59839

In the hope that there is something to be learned from mistakes, I shall outline briefly the situations that have led to accidental prompt-critical radiation bursts in critical assemblies laboratories, and mention a few others that appeared to be risky. Enough has been said of two of the three wartime hand-assembly accidents to underline their tragic lesson. With the abundance of guiding information on critical systems that now exists and the use of remotely-controlled facilities for approaching critical, there is no excuse for recreating the situation where a slip of the hand on part of an assembly makes the system supercritical. The third early incident, illustrates an error that did not depend upon hand operation. A water-tank surrounding a metal assembly in a dry well was being filled at a rate that exceeded the capacity of an overflow opening, water-level indication was inadequate, and the metal assembly flooded, developing a radiation burst of $\sim 3 \times 10^{16}$ fissions. Though the operator peeked into the tank just in time to see a blue glow, there was enough intervening water to protect him from serious injury.

Here (slide 1) is a foolish situation that we set up (most accidents are foolish in retrospect). The aquarium was designed originally for obtaining the neutron multiplication of single pieces of fissionable metal in water. As one scram, a pneumatic cylinder raised the unit out of the water; another, though slow, was draining of the tank. A traveling support for a second unit was added so that critical separation distances could be determined. A dropping Cd screen also was added as a scram. As a flourish after the final measurement planned for the Aquarium, the system illustrated was scrambled, local radiation detectors went off scale and a cloud of steam showed on the monitoring television screen.

397-1

UNCLASSIFIED

~~SECRET~~
 PRO 86510
 as defined in the Atomic Energy Act of 1954
 of
 the

Reconstruction showed that the pneumatic "tangential" scram was the first to be effective and led to two types of difficulty. First, the center of reactivity of the left-hand cylinder (upper part inert metal) proved to be below that of the stationary cylinder, and, second, the rapid lift through water swung the two cylinders together. The total of $\sim 10^{17}$ fissions probably came from several independent bursts separated by bubbling. The next slide (No. 2) shows the end of one of the cylinders, Cd-surrounded, slightly melted at an edge. It may be appropriate now to emphasize the well-known sensitivity of systems like this to separation as the critical value is approached (slide 3) — it is easy to be misled by extrapolation of the reciprocal multiplication curve in evaluating safety of a next step.

The next slide (No. 4) shows another assembly with which we had trouble, this time arithmetic. During build-up to critical, indication that an added plate of enriched uranium would exceed critical by a certain margin was interpreted as subcritical by that same margin (naturally, the smaller number was subtracted from the larger). Too-rapid assembly (increments were available) led to a burst of 7×10^{16} fissions. There was no damage. Incidentally, the light appearance of the upper support (to minimize reflection) worried us, especially for some heavier stacks than shown here. Right or wrong, we accepted it to get a job done rapidly. Returning to the accidental burst, a plot of data (slide 5), as called for by our operating regulations, could not have been misinterpreted.

Another assembly that worried us is indicated in the next slide (No. 6). Rupture of the inner vessel would have dispersed uranyl fluoride throughout a large volume of D_2O , creating a supercritical situation for which scrams would be ineffective. Again, because of convenience and urgency, this situation was tolerated. Pretests of spheres and removal during non-operating periods reduced the probability of leakage.

LEGAL NOTICE

This report was prepared as an account of Government sponsored work. Neither the United States, nor the Commission, nor any person acting on behalf of the Commission:

- Makes any warranty or representation, expressed or implied, with respect to the accuracy, completeness, or usefulness of the information contained in this report, or that the use of any information, apparatus, method, or process disclosed in this report may not infringe privately owned rights; or
- Assumes any liabilities with respect to the use of, or for damages resulting from the use of any information, apparatus, method, or process disclosed in this report.

As used in the above, "person acting on behalf of the Commission" includes any employee or contractor of the Commission, or employee of such contractor, to the extent that such employee or contractor of the Commission, or employee of such contractor prepares, disseminates, or provides access to, any information pursuant to his employment or contract with the Commission, or his employment with such contractor.

UNCLASSIFIED

- 2 -
397-2

UNCLASSIFIED

Dixon Callihan has kindly offered use of his two examples of prompt bursts with uranyl-fluoride solutions. In the first case (slide 7), the Cd-lined central well of a solution annulus tipped to the side when a spacer was pulled out of place by the drive of a liquid-level probe. Apparently there was a sequence of bursts totaling $\sim 10^{17}$ fissions. In the second case (slide 8), a shallow solution was just sufficiently supercritical to actuate scrams. The first scram to be effective, a dropping Cd plate that had been slightly deformed at the bottom, set up a wave which when reflected back from the wall established a super-prompt configuration. There was a geyser of solution, accompanying a burst of $\sim 1.6 \times 10^{17}$ fissions.

In our Honeycomb machine (slide 9), similar to other reactor mockup machines, we had a burst for which we find no clear stopping mechanism other than scrams. (In strictly fast neutron systems, bursts are terminated by thermal expansion before scrams have time to operate.) The active region was formed by long sandwiches of enriched uranium foil (0.005") and graphite that slipped into the Al matrix tubes. Too large a change in the core, and incautious assembly led to the burst of 3×10^{16} fissions (the system became critical beyond the range of a slow-down). Foils were not damaged, and it seems unlikely that longitudinal expansion of them could have stopped the reaction.

Another Honeycomb assembly, shown schematically in the next slide (No. 10), gave us our greatest surprise -- a potentially risky one. Evolution had led from thinner Be islands, in which withdrawal of Be and fuel proved most effective safeties, to this assembly in which the first 6" of "safety" motion gave a 30 cent reactivity gain. Within this range the fuel rods were ineffective and the Be rods worse than nothing. Of course, further withdrawal decreased reactivity.

UNCLASSIFIED

~~SECRET~~

Our two Godiva incidents were in a sense "asked for," as they occurred in connection with intentional prompt critical operations (periods of $< 20 \mu\text{sec}$ replaced our usual 10 sec limit, and backgrounds of < 100 neutrons/sec replaced our usual source requirement of $\sim 10^6$ neutrons/sec). Both accidents occurred during preliminaries that were designed to establish the reactivity slightly below prompt critical. In the first case (slide 11), a 100 μ booster, inserted with control rod in the position of maximum instead of minimum reactivity, led to a burst of 6×10^{16} fissions. The burst of 1.2×10^{17} fissions that retired the old Godiva (and became distorted news) apparently resulted from a shift of a nearby setup (slide 12), that was to be irradiated. In this case, several grams of fine oxide contaminated surroundings (slide 13).

Recognizing the risk of generalizing from a handful of events, one looks for regularities and finds:

- 1) accidental prompt bursts occur,
- 2) they appear sufficiently foolish in retrospect that one hates to admit that they are unavoidable,
- 3) in modern facilities, consequences are generally minor, and
- 4) the yield range is surprisingly small.

About generalization of the last item — we are certain that a much greater yield than any observed can be obtained by dropping one sufficiently large piece of highly enriched uranium on another. However, considering the conditions generally observed in a critical assembly laboratory (limited excess reactivity, limited assembly rate, and auxiliary neutron source), the observed range probably is typical of a large variety of systems. Assuming this, and having been beaten down by history, we put major emphasis on protection of people, and try to guard against remote bursts insofar as economically feasible.

- 4 -
~~SECRET~~

357

4

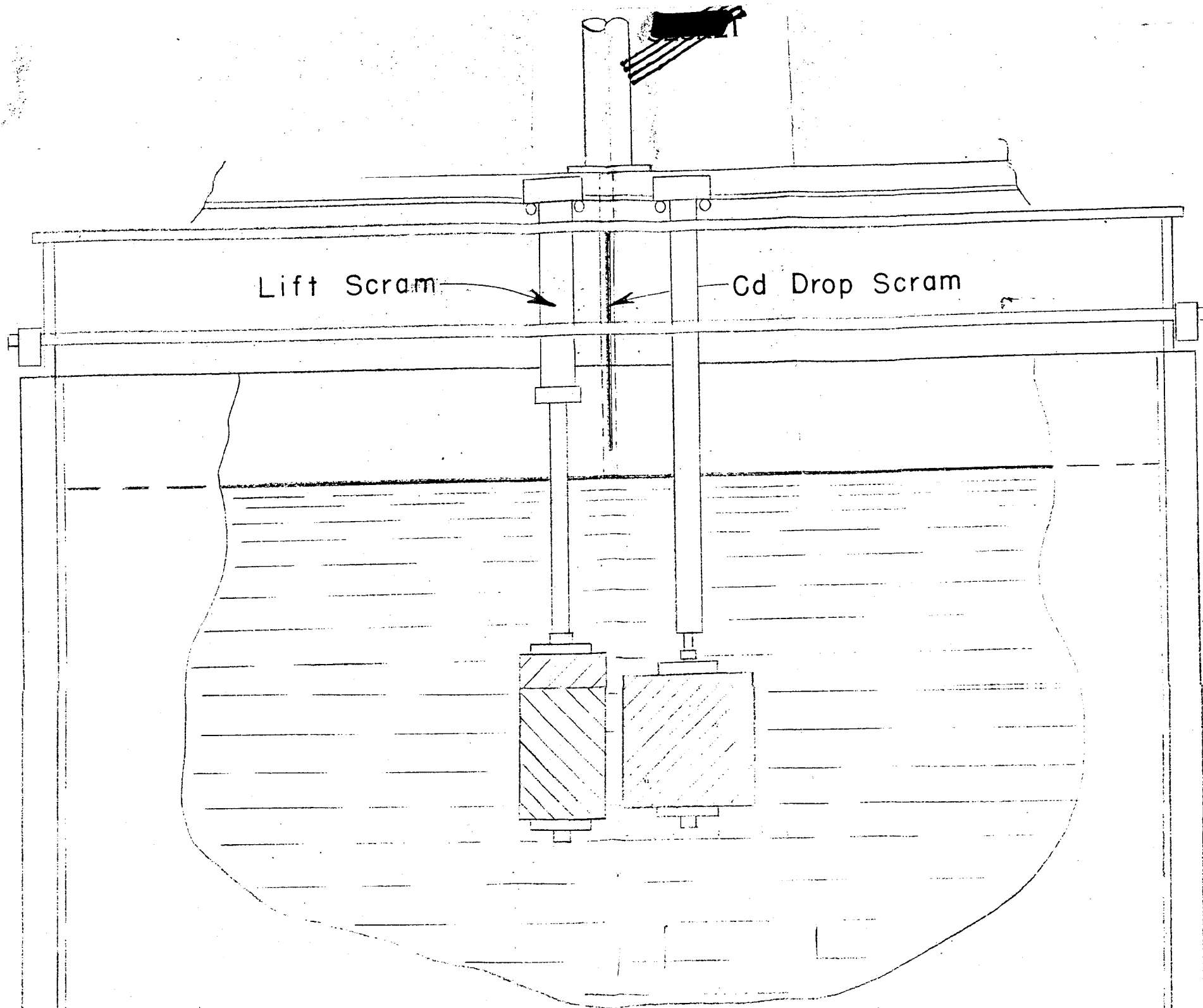

AQUARIUM MACHINE

397-5

①



2

397 - 6

~~SECRET~~

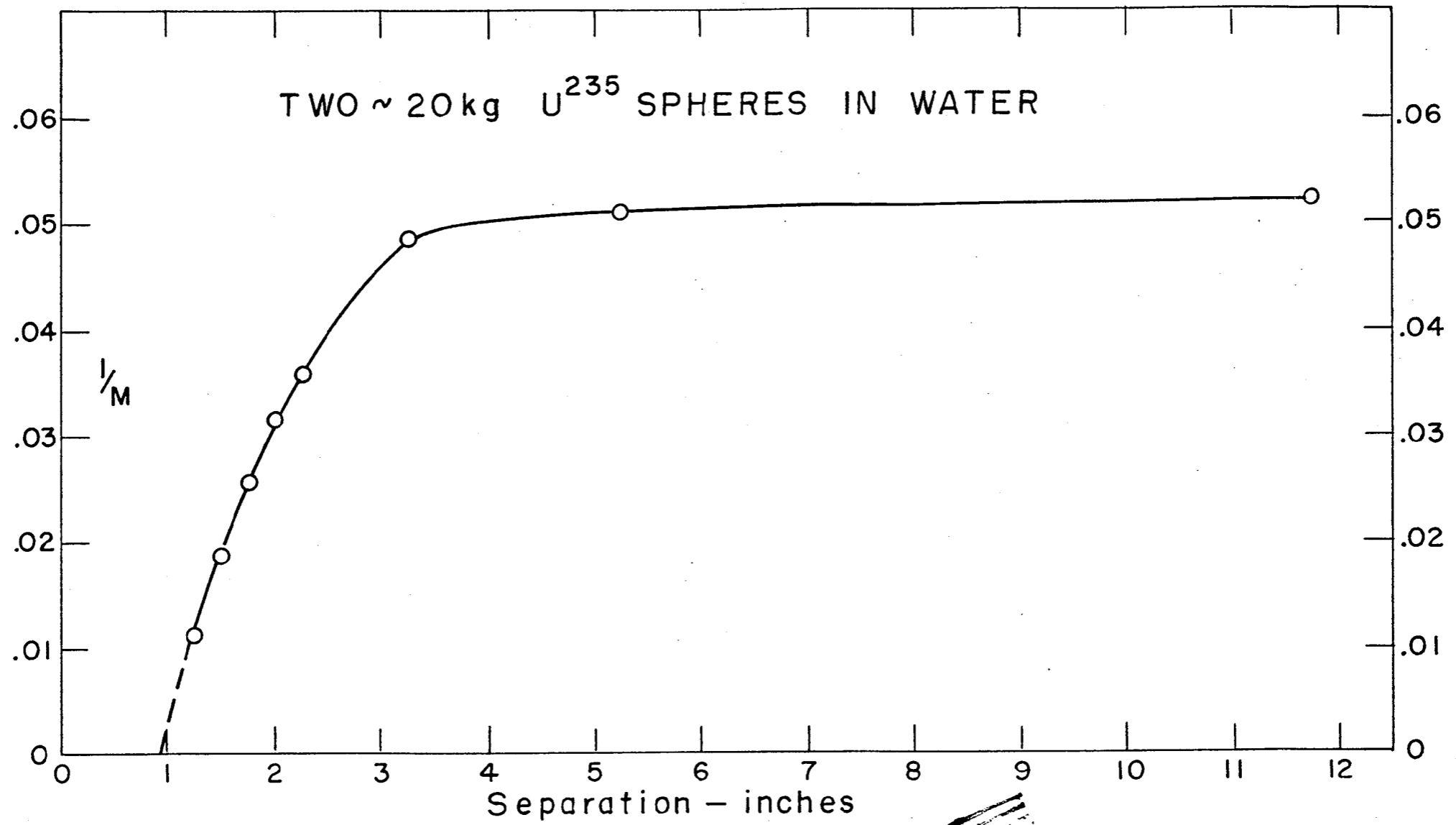

~~SECRET~~

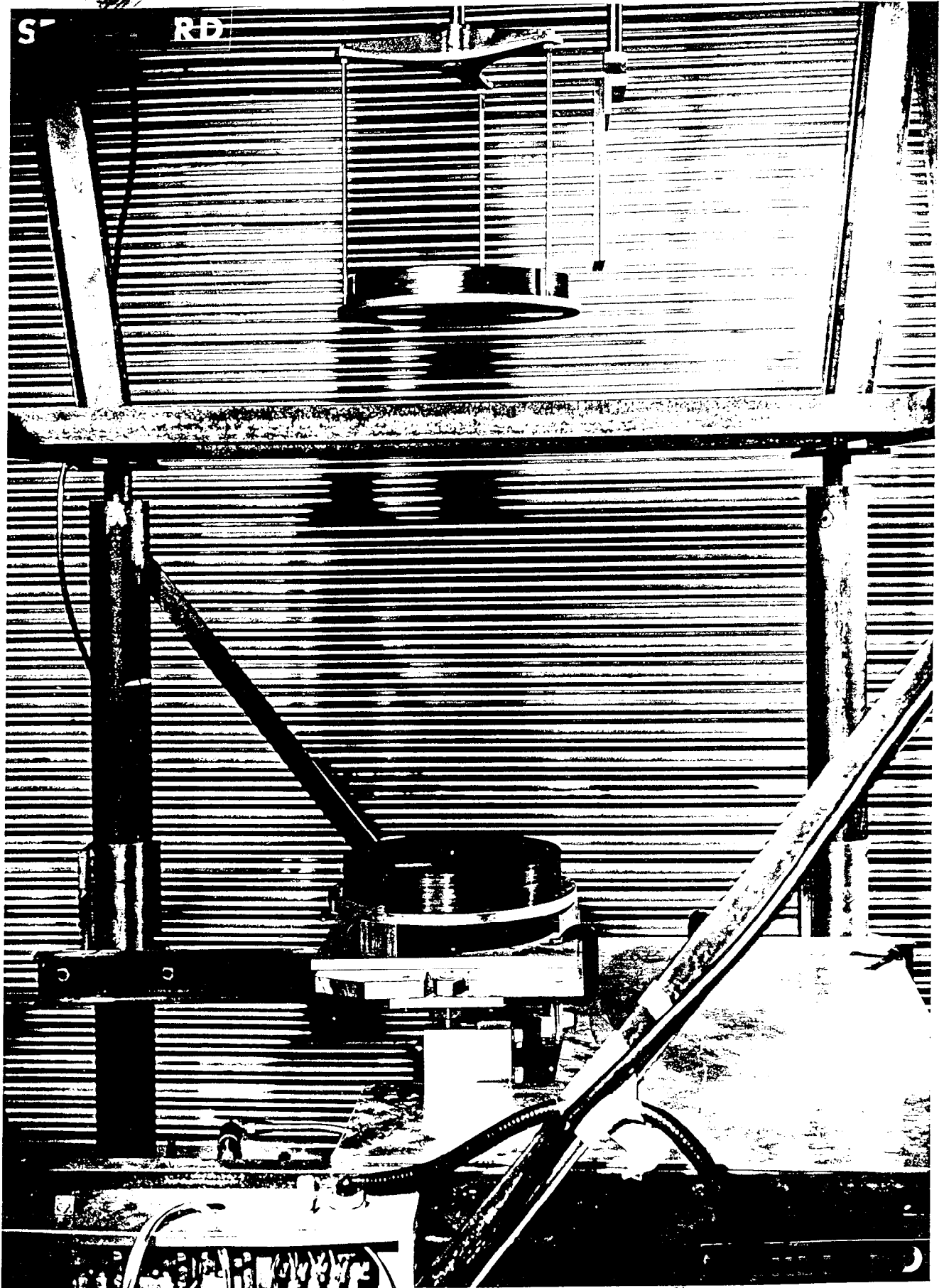

337 2

~~SECRET~~

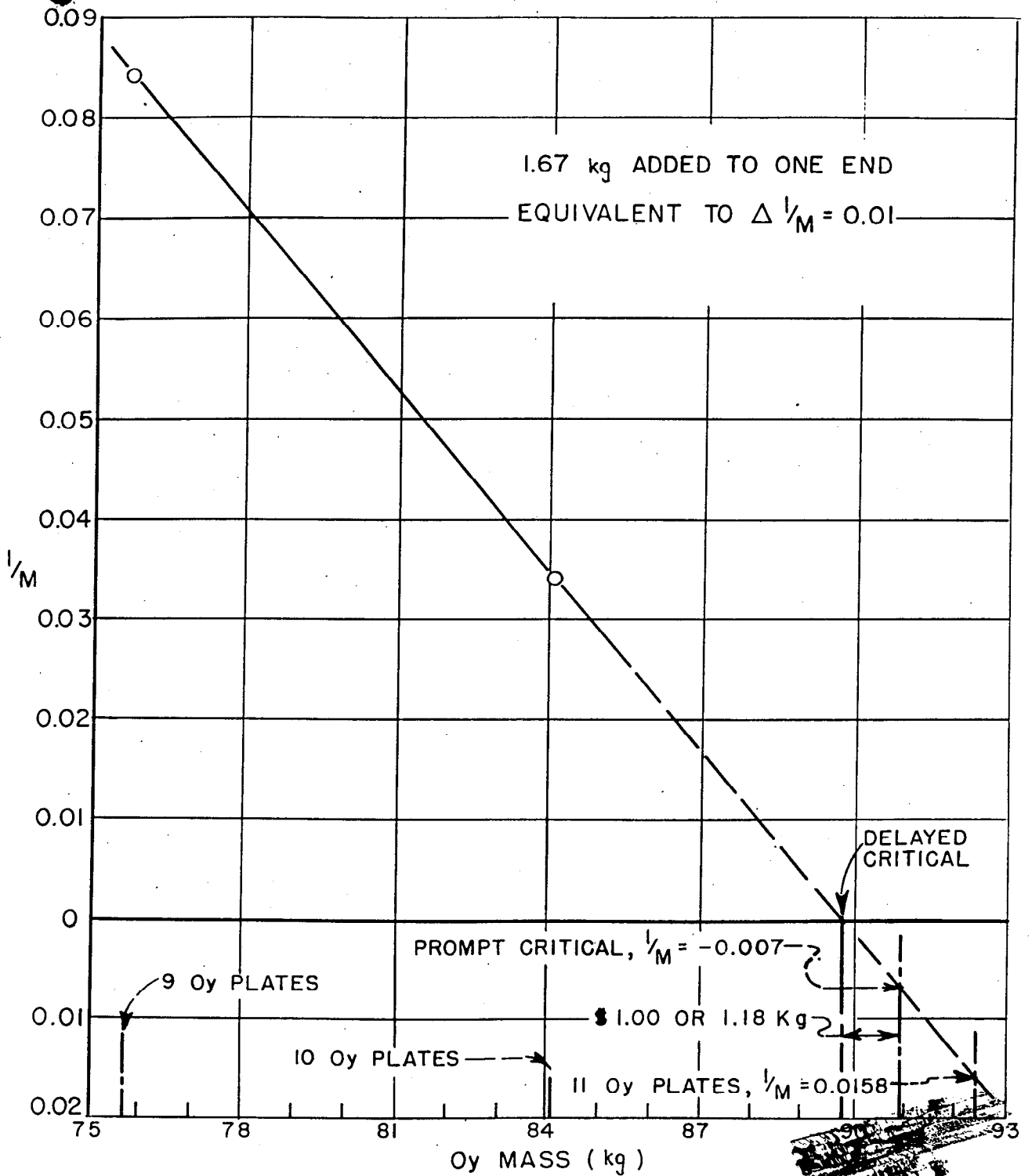

~~SECRET~~

5 397 9

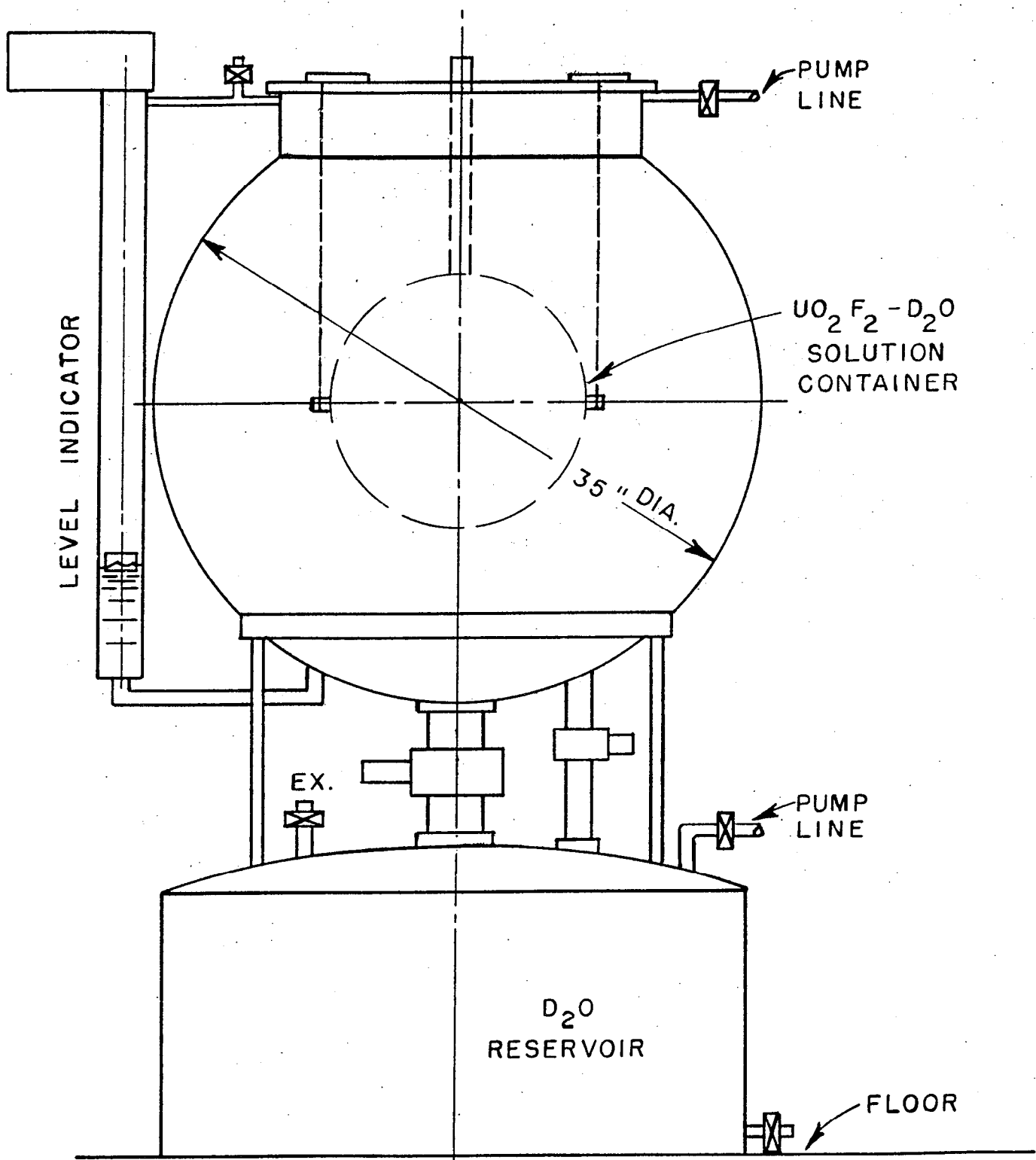

6

397 10

382
11

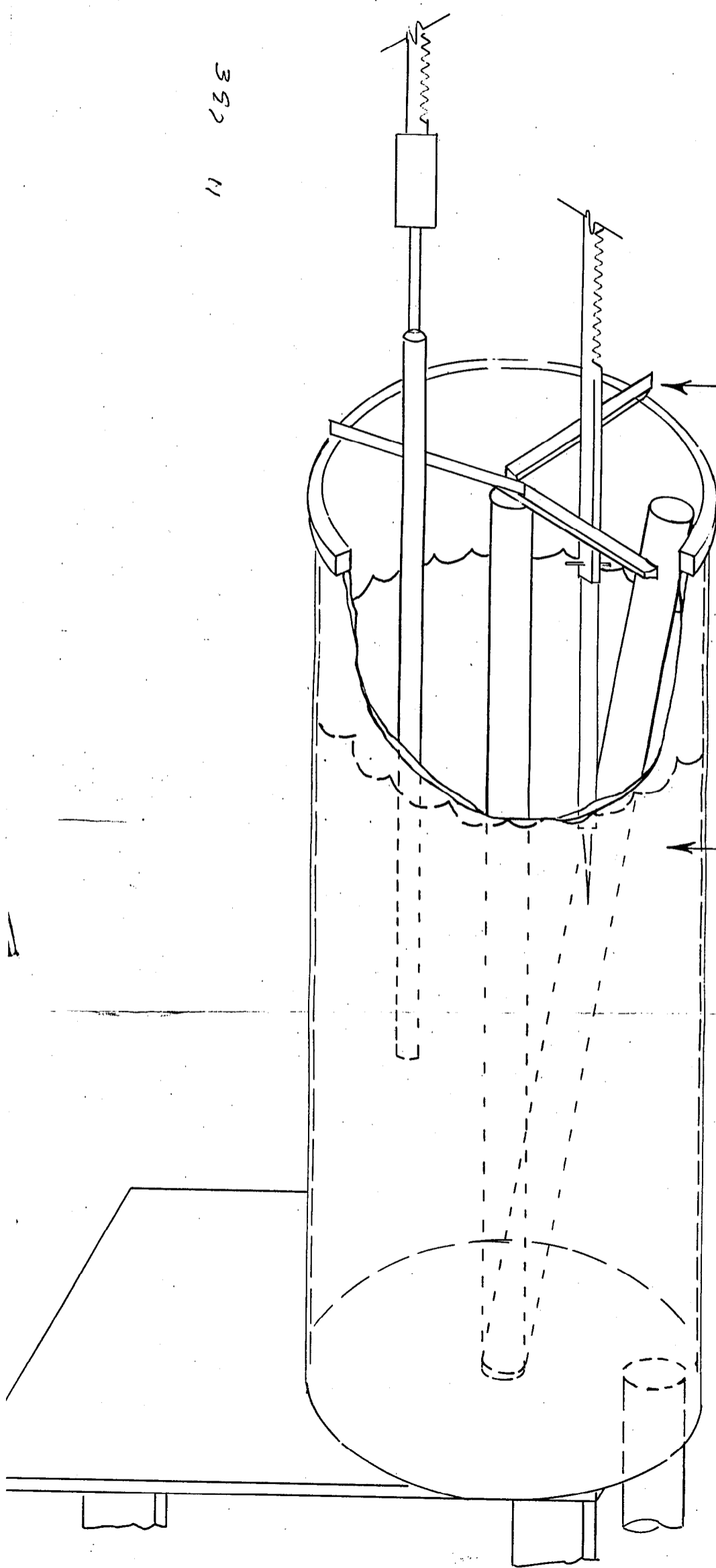

1" Aluminum Spide
Welded

$UO_2F_2 - H_2O$
Solution

347
12

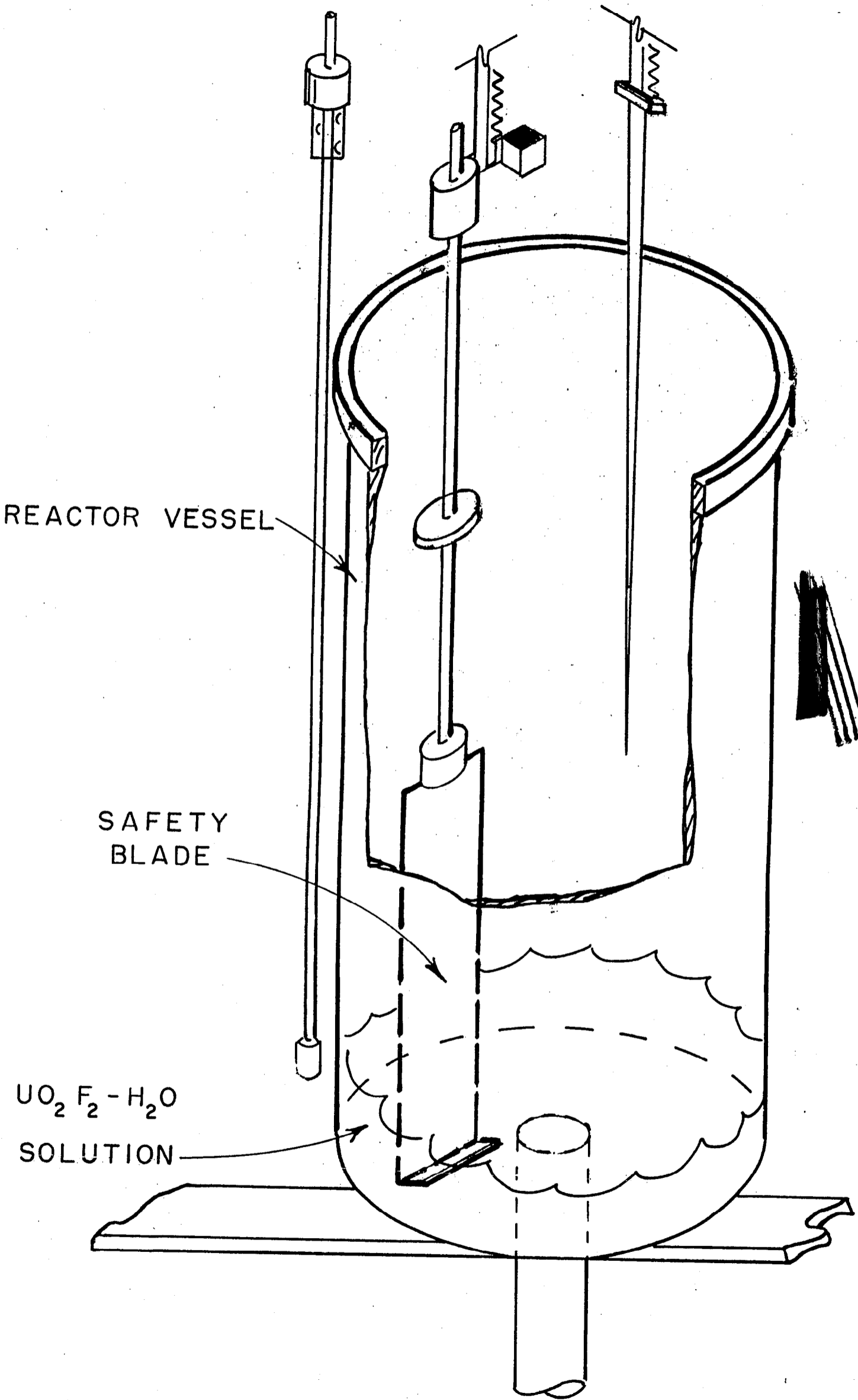

REACTOR VESSEL

SAFETY
BLADE

$UO_2 F_2 - H_2O$
SOLUTION

397-13

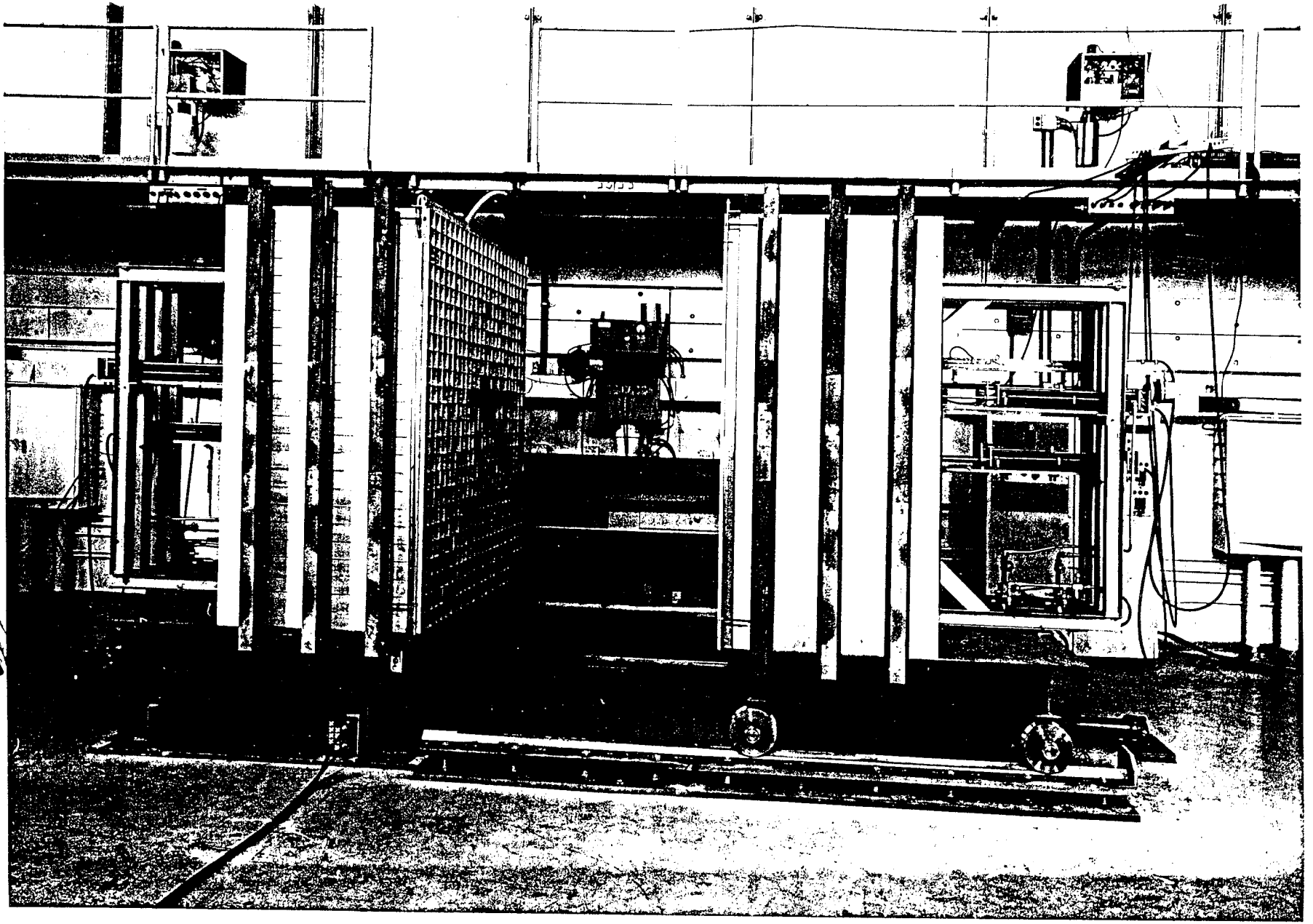

~~TOP SECRET~~

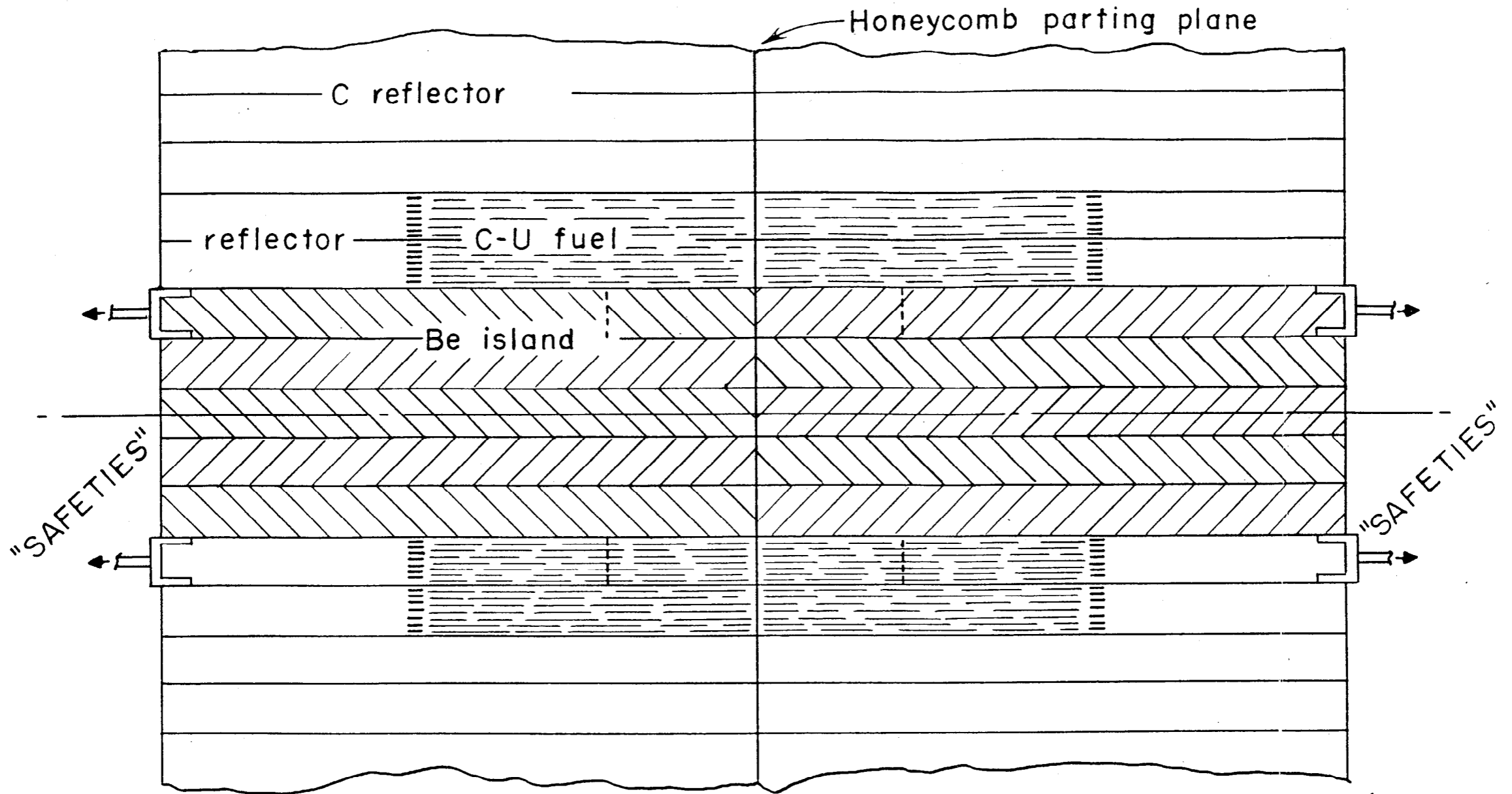

HONEYCOMB ASSEMBLY WITH DANGEROUS "SAFETIES"
(schematic)

397 14

~~TOP SECRET~~

397 14

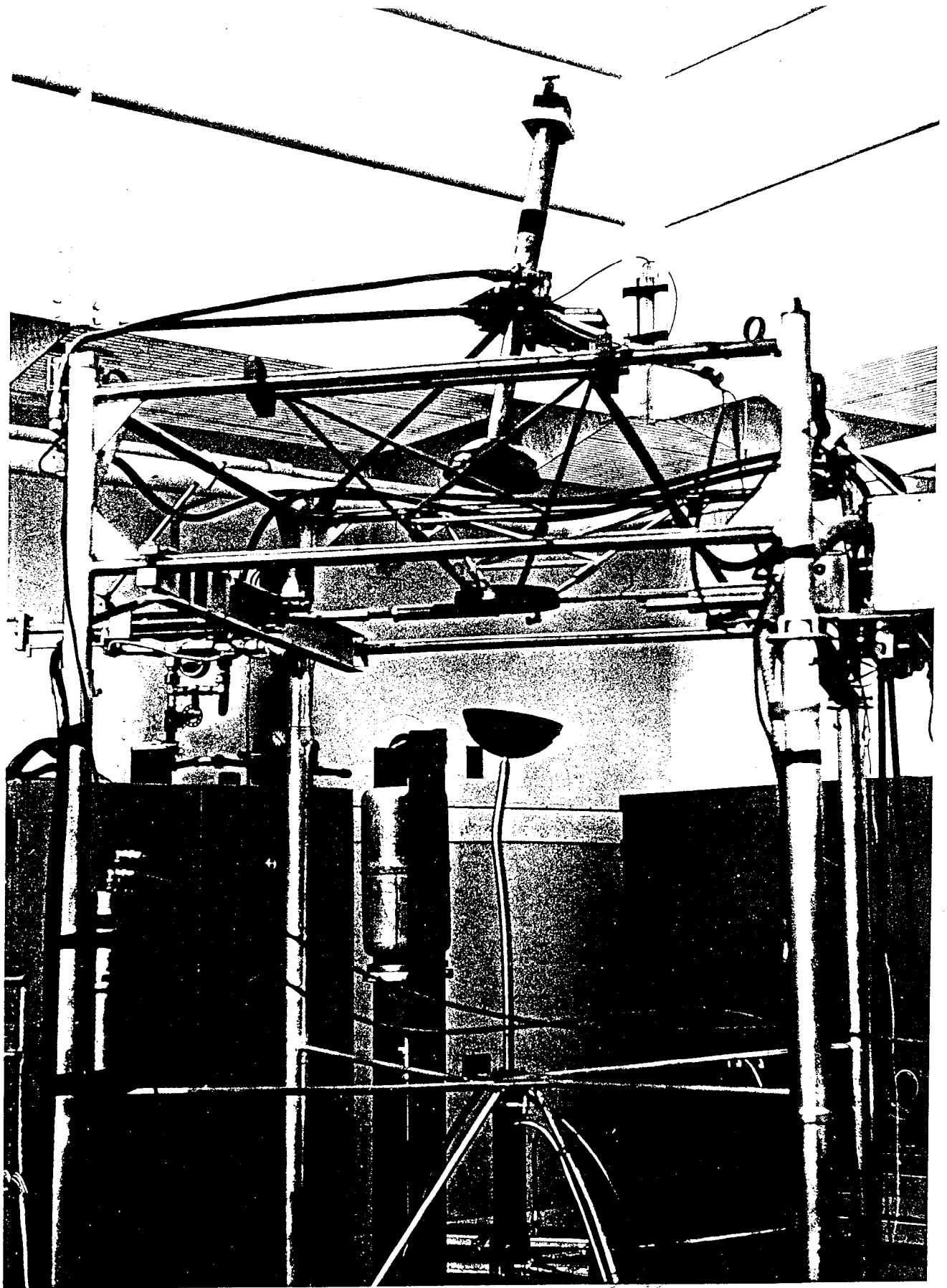

15

15

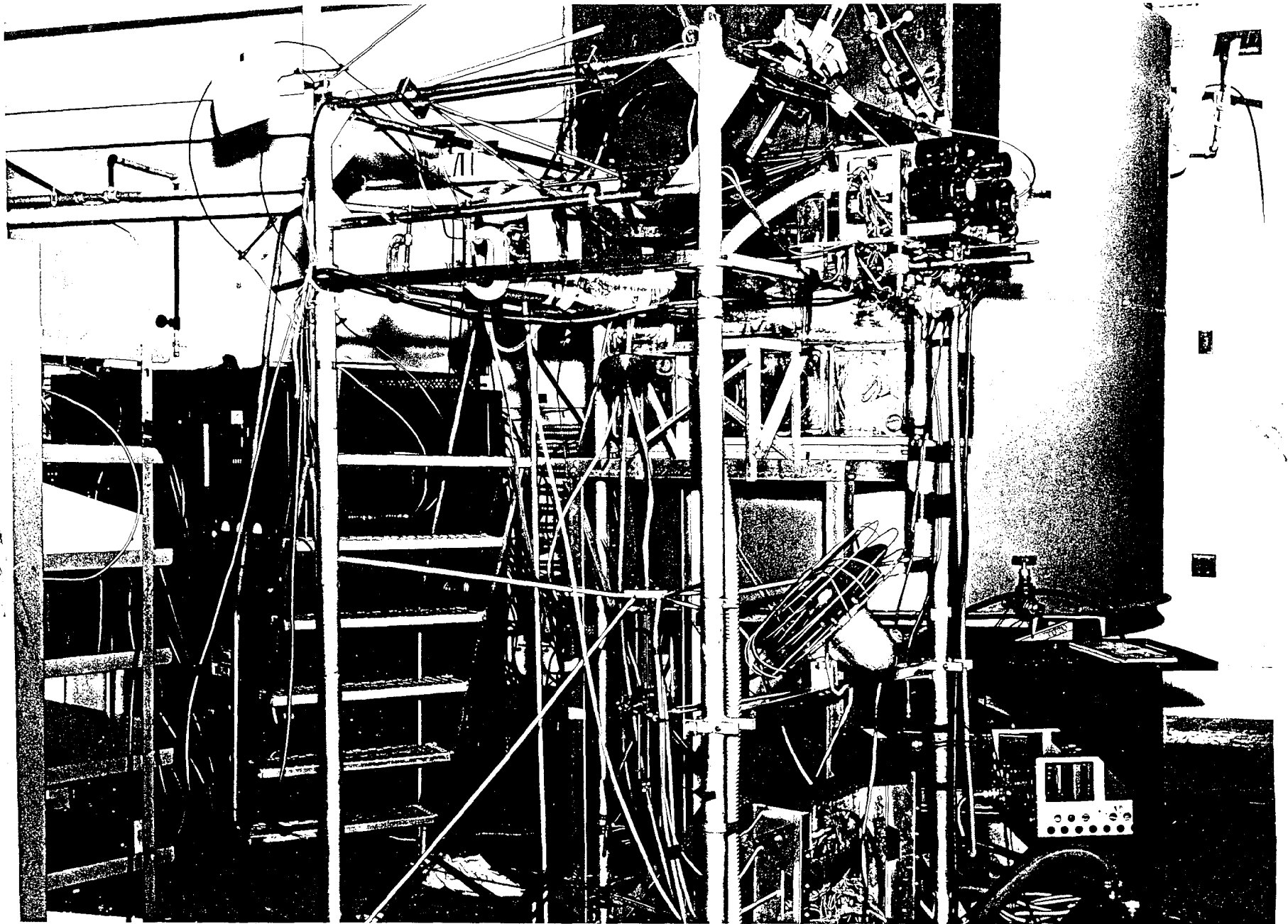

17

